



ETALON
TOOLS



ESZTERGAKÉS KATALÓGUS



etalontools.hu



4262 Nyíracsad, Kolozsvári u. 23.



+36 20 271 2144



info@etalontools.hu

TARTALOMJEGYZÉK

01 KÜLSŐ KÉSEK

02 FURATKÉSEK

03 MENETKÉSEK

04 Beszúró,- leszúró,- és különleges kések



etalontools.hu



4262 Nyíracsad, Kolozsvári u. 23.



+36 20 271 2144



info@etalontools.hu



01. KÜLSŐ KÉSEK



etalontools.hu



4262 Nyíracsád, Kolozsvári u. 23.



+36 20 271 2144



info@etalontools.hu

95° BWLNR/L

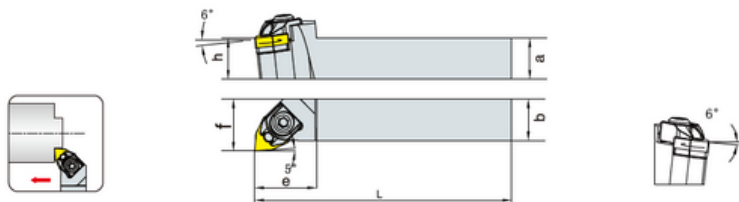

Cikkszám	Méret (mm)						Lapka	Alátét	Szorító csavar	Szorító	Csap	Csavarkulcs	Ár
	a	b	L	h	f	e							
ET-BWLNR/L2020K08	20	20	125	20	25	30	WN..0804..	BW0803	BM6026	BW181509	BM605019	L3\L4	€25
ET-BWLNR/L2525M08	25	25	150	25	32	30							€25
ET-BWLNR/L3232P08	32	32	170	32	40	32							€35

93° BTJNR/L

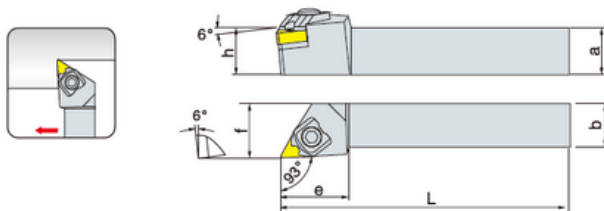

Cikkszám	Méret (mm)						Lapka	Alátét	Szorító csavar	Szorító	Csap	Csavarkulcs	Ár
	a	b	L	h	f	e							
ET-BTJNR/L2020K16	20	20	125	20	25	32	TN..1604..	BT1603	BM6026	BT181509	BM503718	L2.5\L4.0	€25
ET-BTJNR/L2525M16	25	25	150	25	32	32							€25
ET-BTJNR/L3232P16	32	32	170	32	40	34							€35

Szorítókörm + alátétlapka + lapkacsavar + imbuszkulcs szett: €9

95° BCLNR/L

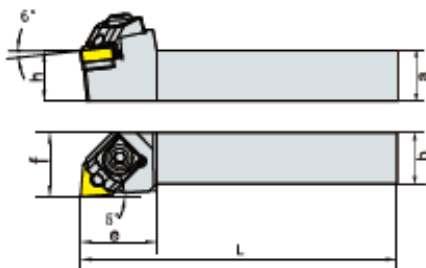

Cikkszám	Méret (mm)						Lapka	Alátét	Szorító csavar	Szorító	Csap	Csavarkulcs	Ár
	a	b	L	h	f	e							
ET-BCLNR/L2020K12	20	20	125	20	25	32	CN..1204..	BC1203	BM6026	BC201509	BM605019	L3\L4	€25
ET-BCLNR/L2525M12	25	25	150	25	32	32							€25
ET-BCLNR/L3232P12	32	32	170	32	40	34							€35

93° BDJNR/L

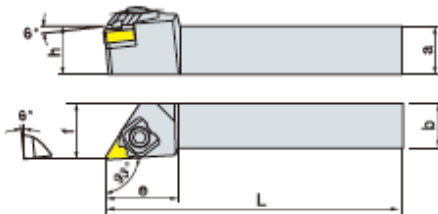

Cikkszám	Méret (mm)						Lapka	Alátét	Szorító csavar	Szorító	Csap	Csavarkulcs	Ár
	a	b	L	h	f	e							
ET-BDJNR/L2020K1506	20	20	125	20	25	40	DN..1506..	BD1503	BM6026	BD241509	BM605019	L3.0\L4.0	€25
ET-BDJNR/L2525M1506	25	25	150	25	32	40							€25
ET-BDJNR/L3232P1506	32	32	170	32	40	42							€35

Szorítókörm + alátétlapka + lapkacsavar + imbuszkulcs szett: €9

60° BTENN

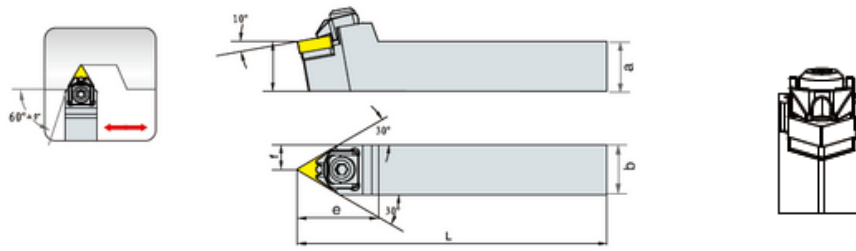

Cikkszám	Méret (mm)						Lapka	Alátét	Szorító csavar	Szorító	Csap	Csavarkulcs	Ár
	a	b	L	h	f	e							
ET-BTENN2020K16	20	20	125	20	10	33							€25
ET-BTENN2525M16	25	25	150	25	12.5	33	TN..1604..	BT1603	BM6026	BT181509	BM503718	L2.5\L4.0	€25
ET-BTENN3232P16	32	32	170	32	16	34							€35

93° BVJNR/L

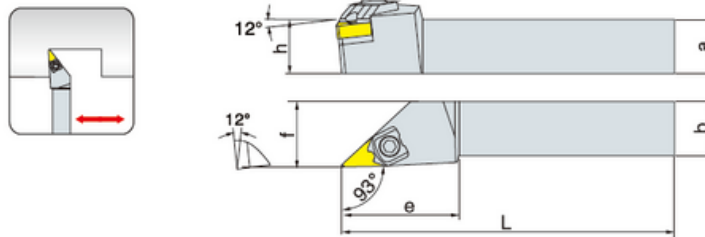

Cikkszám	Méret (mm)						Lapka	Alátét	Szorító csavar	Szorító	Csap	Csavarkulcs	Ár
	a	b	L	h	f	e							
ET-BVJNR/L2020K16	20	20	125	20	25	43							€25
ET-BVJNR/L2525M16	25	25	150	25	32	43	VN..1604..	BT1603	BM6026	BV271509	BM503718	L2.5\L4.0	€25
ET-BVJNR/L3232P16	32	32	170	32	40	44							€35

Szorítóköröm + alátétlapka + lapkacsavar + imbuszkulcs szett: €9

117.5° BVQNR/L

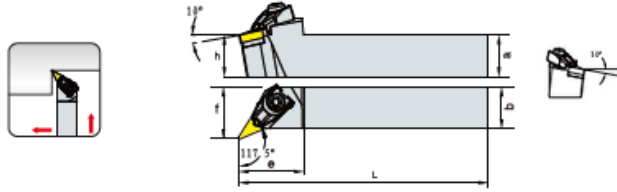

Cikkszám	Méret (mm)						Lapka	Alátét	Szorító csavar	Szorító	Csap	Csavarkulcs	Ár
	a	b	L	h	f	e							
ET-BVQNR/L2020K16	20	20	125	20	25	39	VN..1604..	BT1603	BM6026	BV271509	BM503718	L2.5\L4.0	€25
ET-BVQNR/L2525M16	25	25	150	25	32	39							€25
ET-BVQNR/L3232P16	32	32	170	32	40	40							€35

72.5° BVVNR/L

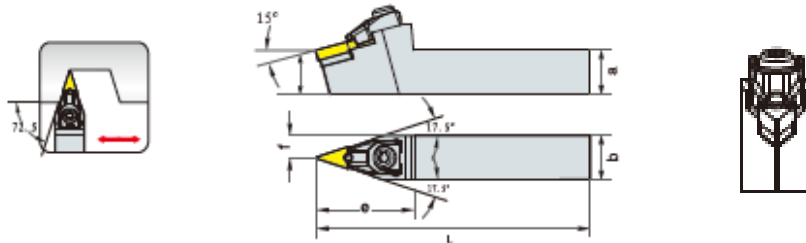

Cikkszám	Méret (mm)						Lapka	Alátét	Szorító csavar	Szorító	Csap	Csavarkulcs	Ár
	a	b	L	h	f	e							
ET-BVVNR/L2020K16	20	20	125	20	10	45	VN..1604..	MT1603	BM6026	BV271509	BM503718	L2.5\L4.0	€25
ET-BVVNR/L2525M16	25	25	150	25	12.5	45							€25
ET-BVVNR/L3232P16	32	32	170	32	16	46							€35

Szorítókörm + alátétlapka + lapkacsavar + imbuszkulcs szett: €9

S-BCLNR/L

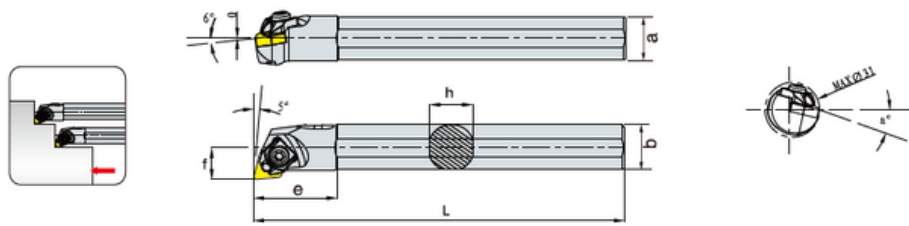

Cikkszám	Méret (mm)						Lapka	Alátét	Szorító csavar	Szorító	Csap	Csavarkulcs	Ár
	a	b	L	h	f	e							
ET-S25R-BCLNR/L12	12	25	200	23	17	45	CN.1204..	---	BM6026	BC201509	BM5605013	L3\L4	€25
ET-S32T-BCLNR/L12	17	32	300	30	22	50							€35
ET-S40T-BCLNR/L12	15	40	300	38	27	52							€35

S-BWLNR/L

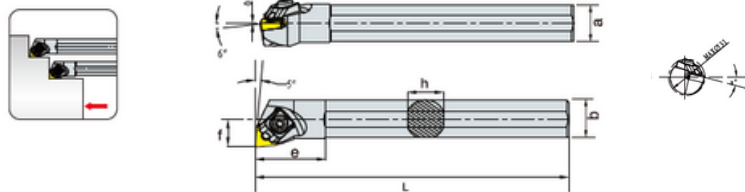

Cikkszám	Méret (mm)						Lapka	Alátét	Szorító csavar	Szorító	Csap	Csavarkulcs	Ár
	a	b	L	h	f	e							
ET-S25R-BWLNR/L08	12	25	200	23	17	45	WN..0804..	BW0803	BM6026	BW181509	BM605013	L3\L4	€25
ET-S32T-BWLNR/L08	17	32	300	30	22	50							€35
ET-S40T-BWLNR/L08	15	40	300	38	27	52							€35

Szorítóköröm + alátétlapka + lapkacsavar + imbuszkulcs szett: €9

95° MCLNR/L

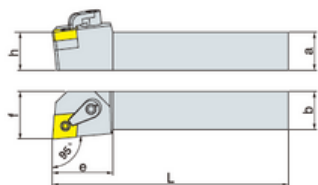

Cikkszám	Méret (mm)						Lapka	Alátét	Szorító csavar	Szorító	Csap	Csavarkulcs	Ár
	a	b	L	h	f	e							
ET-MCLNR/L1616H12	16	16	100	16	20	32	CN..1204..	MC1204	ML0625	HL1814	CTM617	L2.5\L3.0	€25
ET-MCLNR/L2020K12	20	20	125	20	25	32							€25
ET-MCLNR/L2525M12	25	25	150	25	32	32							€25
ET-MCLNR/L3232P12	32	32	170	32	40	32							€35
ET-MCLNR/L2525M16	25	25	150	25	32	35	CN..1606..	MC1604	ML0830	HL2217	CTM822	L3.0\L4.0	€25
ET-MCLNR/L3232P16	32	32	170	32	40	35							€35
ET-MCLNR/L3232P19	32	32	170	32	40	36	CN..1906..	MC1904	ML0830	HL2217	CTM1022	L4.0	€35
ET-MCLNR/L4040R19	40	40	200	40	50	36							€35

91° MCFNR/L

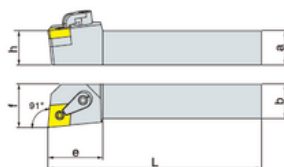

Cikkszám	Méret (mm)						Lapka	Alátét	Szorító csavar	Szorító	Csap	Csavarkulcs	Ár
	a	b	L	h	f	e							
ET-MCFNR/L2020K12	20	20	125	20	25	32	CN..1204..	MC1204	ML0625	HL1814	CTM617	L2.5\L3.0	€25
ET-MCFNR/L2525M12	25	25	150	25	32	32							€25
ET-MCFNR/L3232P12	32	32	170	32	40	32							€35

Szorítókörm + alátétlapka + lapkacsavar + imbuszkulcs szett: €9

91° MCGNR/L

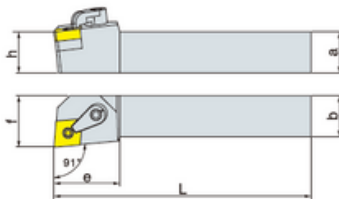

Cikkszám	Méret (mm)						Lapka	Alátét	Szorító csavar	Szorító	Csap	Csavarkulcs	Ár
	a	b	L	h	f	e							
ET-MCGNR/L2020K12	20	20	125	20	25	32	CN..1204..	MC1204	ML0625	HL1814	CTM617	L2.5\L3.0	€25
ET-MCGNR/L2525M12	25	25	150	25	32	32							€25
ET-MCGNR/L3232P12	32	32	170	32	40	32							€35
ET-MCGNR/L3232P16	32	32	170	32	40	36	CN..1606..	MC1604	ML0830	HL2217	CTM822	L3.0\L4.0	€35
ET-MCGNR/L3232P19	32	32	170	32	40	38	CN..1906..	MC1904	ML0830	HL2217	CTM1022	L4.0	€35

75° MCKNR/L

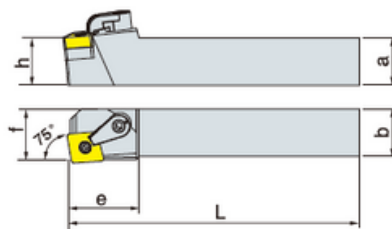
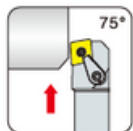

Cikkszám	Méret (mm)						Lapka	Alátét	Szorító csavar	Szorító	Csap	Csavarkulcs	Ár
	a	b	L	h	f	e							
ET-MCKNR/L2020K12	20	20	125	20	32.5	17	CN..1204..	MC1204	ML0625	HL1814	CTM617	L2.5\L3.0	€25
ET-MCKNR/L2525M12	25	25	150	25	32.5	22							€25
ET-MCKNR/L3232P12	32	32	170	32	32.5	27							€35
ET-MCKNR/L3232P16	32	32	170	32	40	27	CN..1606..	MC1604	ML0830	HL2217	CTM822	L3.0\L4.0	€35
ET-MCKNR/L3232P19	32	32	170	32	40	27	CN..1906..	MC1904	ML0830	HL2217	CTM1022	L4.0	€35

Szorítókörm + alátétlapka + lapkacsavar + imbuszkulcs szett: €9

75° MCBNR/L

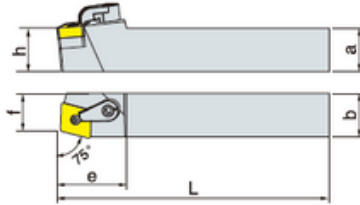
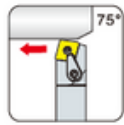

Cikkszám	Méret (mm)						Lapka	Alátét	Szorító csavar	Szorító	Csap	Csavarkulcs	Ár
	a	b	L	h	f	e							
ET-MCBNR/L2020K12	20	20	125	20	32.5	17	CN.1204..	MC1204	ML0625	HL1814	CTM617	L2.5\L3.0	€25
ET-MCBNR/L2525M12	25	25	150	25	32.5	22							€25
ET-MCBNR/L3232P12	32	32	170	32	32.5	27							€35
ET-MCBNR/L3232P16	32	32	170	32	40	27	CN.1606..	MC1604	ML0830	HL2217	CTM822	L3.0\L4.0	€35
ET-MCBNR/L3232P19	32	32	170	32	40	27	CN.1906..	MC1904	ML0830	HL2217	CTM1022	L4.0	€35

50° MCMNN

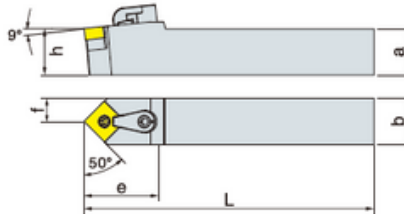
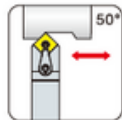

Cikkszám	Méret (mm)						Lapka	Alátét	Szorító csavar	Szorító	Csap	Csavarkulcs	Ár
	a	b	L	h	f	e							
ET-MCMNN2020K12	20	20	125	20	10	35	CN.1204..	MC1204	ML0625	HL1814	CTM617	L2.5\L3.0	€25
ET-MCMNN2525M12	25	25	150	25	12.5	35							€25
ET-MCMNN3232P12	32	32	170	32	16	35							€35
ET-MCMNN2525M16	25	25	150	25	12.5	42	CN.1606..	MC1604	ML0830	HL2217	CTM822	L3.0\L4.0	€25

Szorítókörm + alátétlapka + lapkacsavar + imbuszkulcs szett: €9

40° MCMNN-100

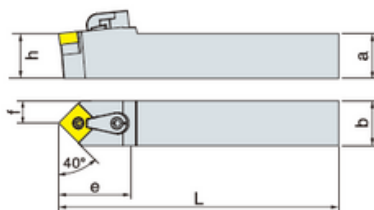
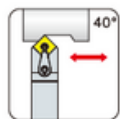

Cikkszám	Méret (mm)						Lapka	Alátét	Szorító csavar	Szorító	Csap	Csavarkulcs	Ár
	a	b	L	h	f	e							
ET-MCMNN2020K12-100	20	20	125	20	10	35	CN.1204..	MCI204	ML0625	HL1814	CTM617	L2.5\L3.0	€25
ET-MCMNN2525M12-100	25	25	150	25	12.5	35							€25
ET-MCMNN3232P12-100	32	32	170	32	16	35							€35
ET-MCMNN2525M16-100	25	25	150	25	12.5	42	CN.1606..	MCI604	ML0830	HL2217	CTM822	L3.0\L4.0	€25
ET-MCMNN3232P16-100	32	32	170	32	16	42							€35

45° MCSNR/L

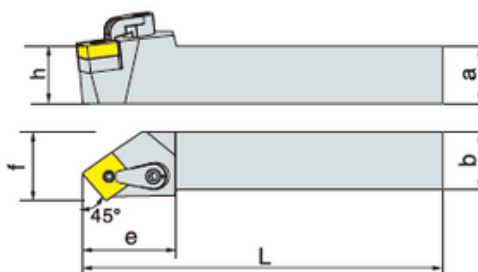
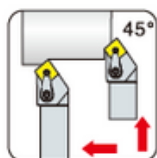

Cikkszám	Méret (mm)						Lapka	Alátét	Szorító csavar	Szorító	Csap	Csavarkulcs	Ár
	a	b	L	h	f	e							
ET-MCSNR/L2020K12	20	20	125	20	25	32	CN.1204..	MCI204	ML0625	HL1814	CTM617	L2.5\L3.0	€25
ET-MCSNR/L2525M12	25	25	150	25	32	32							€25
ET-MCSNR/L3232P12	32	32	170	32	40	32							€35
ET-MCSNR/L3232P19	32	32	170	32	40	36	CN.1906..	MCI904	ML0830	HL2217	CTM1022	L4.0	€35

Szorítókörm + alátétlapka + lapkacsavar + imbuszkulcs szett: €9

93° MDJNR/L

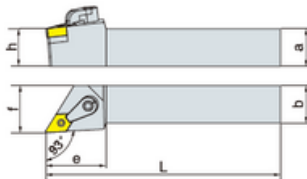

Cikkszám	Méret (mm)						Lapka	Alátét	Szorító csavar	Szorító	Csap	Csavarkulcs	Ár
	a	b	L	h	f	e							
ET-MDJNR/L1616H11	16	16	100	16	20	32	DN.1104..	MD1103	ML0625	HL1814	CTM513	L2.0\ L3.0	€25
ET-MDJNR/L2020K11	20	20	125	20	25	32							€25
ET-MDJNR/L2525M11	25	25	150	25	32	32							€25
ET-MDJNR/L2020K15	20	20	125	20	25	38	DN.1504.. DN.1506..	MD1506 MD1504	ML0625	HL2114	CTM619	L2.5\ L3.0	€25
ET-MDJNR/L2525M15	25	25	150	25	32	38							€25
ET-MDJNR/L3232P15	32	32	170	32	40	38							€35

62.5° MDPNN

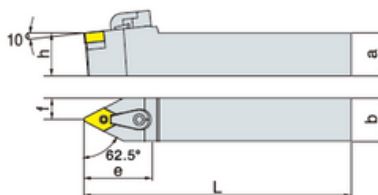
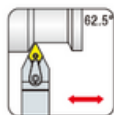

Cikkszám	Méret (mm)						Lapka	Alátét	Szorító csavar	Szorító	Csap	Csavarkulcs	Ár
	a	b	L	h	f	e							
ET-MDPNN1616H11	16	16	100	16	8	35	DN.1104..	MD1103	ML0625	HL2114	CTM513	L2.0\ L3.0	€25
ET-MDPNN2020K11	20	20	125	20	10	35							€25
ET-MDPNN2020K15	20	20	125	20	10	42	DN.1504.. DN.1506..	MD1506 MD1504	ML0625	HL2114	CTM619	L2.5\ L3.0	€25
ET-MDPNN2525M15	25	25	150	25	12.5	42							€25

Szorítóköröm + alátétlapka + lapkacsavar + imbuszkulcs szett: €9

107.5° MDQNR/L

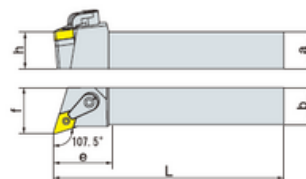

Cikkszám	Méret (mm)						Lapka	Alátét	Szorító csavar	Szorító	Csap	Csavarkulcs	Ár
	a	b	L	h	f	e							
ET-MDQNR/L1616H11	16	16	100	16	20	30	DN..1104..	MD1104	ML0625	HL1814	CTM513	L2.0\ L3.0	€25
ET-MDQNR/L2020K11	20	20	125	20	25	30				€25			
ET-MDQNR/L2525M11	25	25	150	25	32	30				€25			
ET-MDQNR/L2020K15	20	20	125	20	25	36	DN..1504.. DN..1506..	MD1506 MD1504	ML0625	HL2114	CTM619	L2.5\ L3.0	€25
ET-MDQNR/L2525M15	25	25	150	25	32	36				€25			
ET-MDQNR/L3232P15	32	32	170	32	40	36				€35			

75° MSBNR/L

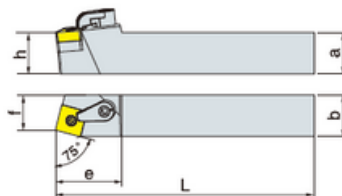
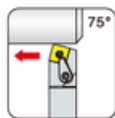

Cikkszám	Méret (mm)						Lapka	Alátét	Szorító csavar	Szorító	Csap	Csavarkulcs	Ár
	a	b	L	h	f	e							
ET-MSBNR/L2020K12	20	20	125	20	32.5	17	SN..1204..	MS1204	ML0625	HL1814	CTM617	L2.5\ L3.0	€25
ET-MSBNR/L2525M12	25	25	150	25	32.5	22							€25
ET-MSBNR/L3232P12	32	32	170	32	32.5	27							€35
ET-MSBNR/L3232P19	32	32	170	32	40	27	SN..1906..	MS1904	ML0830	HL2217	CTM1022	L4.0	€35
ET-MSBNR/L4040R19	40	40	200	40	40	35							€35

Szorítóköröm + alátétlapka + lapkacsavar + imbuszkulcs szett: €9

45° MSDNN

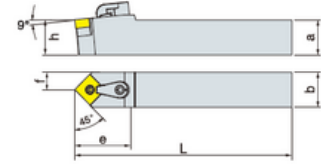

Cikkszám	Méret (mm)						Lapka	Alátét	Szorító csavar	Szorító	Csap	Csavarkulcs	Ár
	a	b	L	h	f	e							
ET-MSDNN1616H12	16	16	100	16	8	34	SN..1204..	MS1204	ML0625	HL1814	CTM617	L2.5\3.0	€25
ET-MSDNN2020K12	20	20	125	20	10	34							€25
ET-MSDNN2525M12	25	25	150	25	12.5	34							€25
ET-MSDNN3232P12	32	32	170	32	16	34							€35
ET-MSDNN2525M15	25	25	150	25	12.5	40	SN..1506..	MS1504	ML0830	HL2217	CTM0822	L3.0\L4.0	€25
ET-MSDNN3232P15	32	32	170	32	16	40							€35
ET-MSDNN3232P19	32	32	170	32	16	40	SN..1906..	MS1904	ML0830	HL2217	CTM1022	L4.0	€35
ET-MSDNN4040R19	40	40	200	40	20	40							€35

75° MSKNR/L

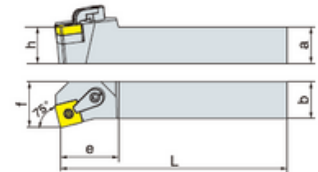
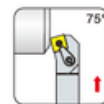

Cikkszám	Méret (mm)						Lapka	Alátét	Szorító csavar	Szorító	Csap	Csavarkulcs	Ár
	a	b	L	h	f	e							
ET-MSKNR/L2020K12	20	20	125	20	25	29	SN..1204..	MS1204	ML0625	HL1814	CTM617	L2.5\3.0	€25
ET-MSKNR/L2525M12	25	25	150	25	32	29							€25
ET-MSKNR/L2525M15	25	25	150	25	32	32	SN..1506..	MS1504	ML0830	HL2217	CTM0822	L3.0\L4.0	€25
ET-MSKNR/L3232P15	32	32	170	32	40	32							€35
ET-MSKNR/L3232P19	32	32	170	32	40	36	SN..1906..	MS1904	ML0830	HL2217	CTM1022	L4.0	€35
ET-MSKNR/L4040R19	40	40	250	40	50	40							€35

Szorítókörm + alátétlapka + lapkacsavar + imbuszkulcs szett: €9

45° MSSNR/L

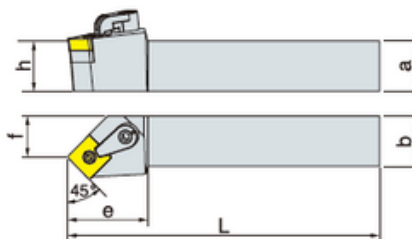
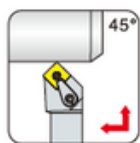

Cikkszám	Méret (mm)						Lapka	Alátét	Szorító csavar	Szorító	Csap	Csavarkulcs	Ár
	a	b	L	h	f	e							
ET-MSSNR/L2020K12	20	20	125	20	25	34	SN..1204..	MS1204	ML0625	HL1814	CTM617	L2.5\L3.0	€25
ET-MSSNR/L2525M12	25	25	150	25	32	34							€25
ET-MSSNR/L3232P12	32	32	170	32	40	34							€35
ET-MSSNR/L2525M15	25	25	150	25	32	36	SN..1506..	MS1504	ML0830	HL2217	CTM0822	L3.0\L4.0	€25
ET-MSSNR/L3232P15	32	32	170	32	40	45							€35
ET-MSSNR/L3232P19	32	32	170	32	40	45	SN..1906..	MS1904	ML0830	HL2217	CTM1022	L4.0	€35
ET-MSSNR/L4040S19	40	40	250	40	50	50							€35

75° MTBNR/L

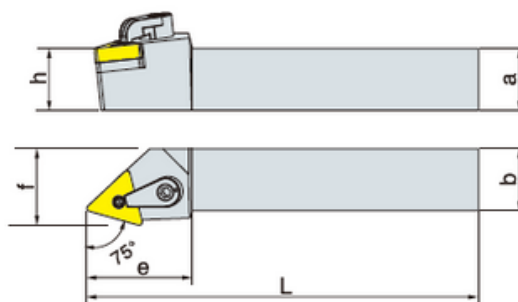
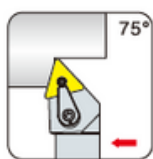

Cikkszám	Méret (mm)						Lapka	Alátét	Szorító csavar	Szorító	Csap	Csavarkulcs	Ár
	a	b	L	h	f	e							
ET-MTBNR/L2020K16	20	20	125	20	25	28	TN..1604..	MT1603	ML0625	HL1814	CTM513	L2.0\L3.0	€25
ET-MTBNR/L2525M16	25	25	150	25	32	28							€25

Szorítókörm + alátétlapka + lapkacsavar + imbuszkulcs szett: €9

60° MTENN

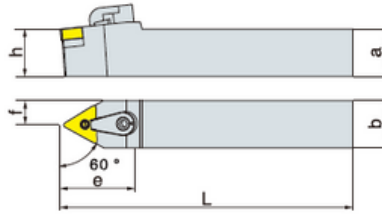
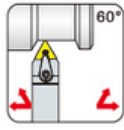

Cikkszám	Méret (mm)						Lapka	Alátét	Szorító csavar	Szorító	Csap	Csavarkulcs	Ár
	a	b	L	h	f	e							
ET-MTENN1616H16	16	16	100	16	8	35	TN..1604..	MT1603	ML0625	HL1814	CTM513	L2.0\L3.0	€25
ET-MTENN2020K16	20	20	125	20	10	35							€25
ET-MTENN2525M16	25	25	150	25	12.5	35							€25
ET-MTENN3232P16	32	32	170	32	16	35							€35
ET-MTENN4040R16	40	40	200	40	20	35							€35
ET-MTENN2525M22	25	25	150	25	12.5	38	TN..2204..	MT2204	ML0830	HL1917	CTM617	L2.5\L4.0	€25
ET-MTENN3232P22	32	32	170	32	16	38							€35

91° MTFNR/L

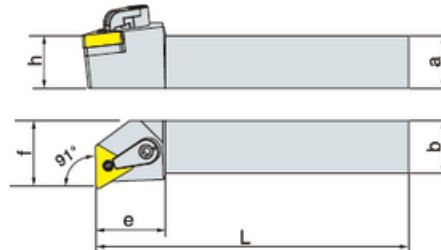
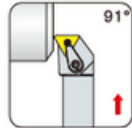

Cikkszám	Méret (mm)						Lapka	Alátét	Szorító csavar	Szorító	Csap	Csavarkulcs	Ár
	a	b	L	h	f	e							
ET-MTFNR/L 1616H16	16	16	100	16	20	28	TN..1604..	MT1603	ML0625	HL1814	CTM513	L2.0\L3.0	€25
ET-MTFNR/L2020K16	20	20	125	20	25	28							€25
ET-MTFNR/L2525M16	25	25	150	25	32	28							€25
ET-MTFNR/L3232P16	32	32	170	32	40	28							€35
ET-MTFNR/L2525M22	25	25	150	25	32	32	TN..2204..	MT2204	ML0830	HL1917	CTM617	L2.5\L4.0	€25
ET-MTFNR/L3232P22	32	32	170	32	32	32							€35

Szorítókörm + alátétlapka + lapkacsavar + imbuszkulcs szett: €9

91° MTGNR/L

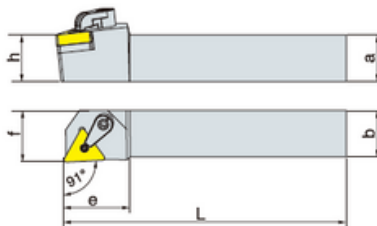
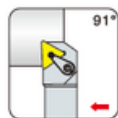

Cikkszám	Méret (mm)						Lapka	Alátét	Szorító csavar	Szorító	Csap	Csavarkulcs	Ár
	a	b	L	h	f	e							
ET-MTGNR/L1616H16	16	16	100	16	20	28	TN..1604..	MT1603	ML0625	HL1814	CTM513	L2.0\ L3.0	€25
ET-MTGNR/L2020K16	20	20	125	20	25	28							€25
ET-MTGNR/L2525M16	25	25	150	25	32	28							€25
ET-MTGNR/L2525P22	25	25	150	25	32	32	TN..2204..	MT2204	ML0830	HL1917	CTM617	L2.5\ L4.0	€25
ET-MTGNR/L2525P22	32	32	170	32	40	32							€25

93° MTJNR/L

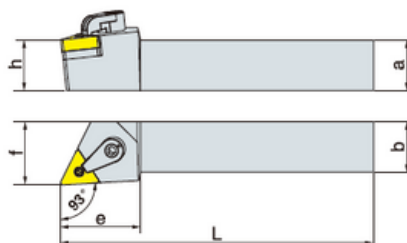
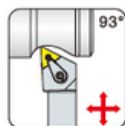

Cikkszám	Méret (mm)						Lapka	Alátét	Szorító csavar	Szorító	Csap	Csavarkulcs	Ár
	a	b	L	h	f	e							
ET-MTJNR/L1616H16	16	16	100	16	20	28	TN..1604..	MT1603	ML0625	HL1814	CTM513	L2.0\ L3.0	€25
ET-MTJNR/L2020K16	20	20	125	20	25	28							€25
ET-MTJNR/L2525M16	25	25	150	25	32	28							€25
ET-MTJNR/L3232P16	32	32	170	32	40	28	TN..2204..	MT2204	ML0830	HL1917	CTM617	L2.5\ L4.0	€35
ET-MTJNR/L2525M22	25	25	150	25	32	32							€25
ET-MTJNR/L3232P22	32	32	170	32	32	32							€35
ET-MTJNR/L4040R22	40	40	200	40	50	32							€35

Szorítókörm + alátétlapka + lapkacsavar + imbuszkulcs szett: €9

105° MTQNR/L

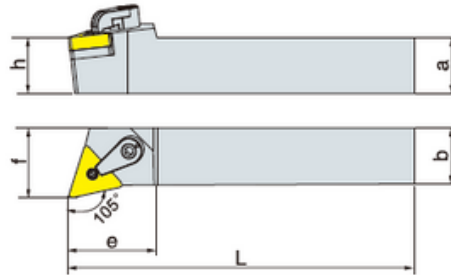
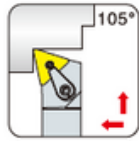

Cikkszám	Méret (mm)						Lapka	Alátét	Szorító csavar	Szorító	Csap	Csavarkulcs	Ár
	a	b	L	h	f	e							
ET-MTQNR/L2020K16	20	20	125	20	25	26	TN.1604..	MT1604	ML0625	HL1814	CTM513	L2.0\L3.0	€25
ET-MTQNR/L2525M16	25	25	150	25	32	26							€25
ET-MTQNR/L3232P16	32	32	170	32	40	26							€35
ET-MTQNR/L2525M22	25	25	150	25	32	32	TN.2204..	MT2204	ML0830	HL1917	CTM617	L2.5\L4.0	€25
ET-MTQNR/L3232P22	32	32	170	32	40	32							€35

93° MVJNR/L

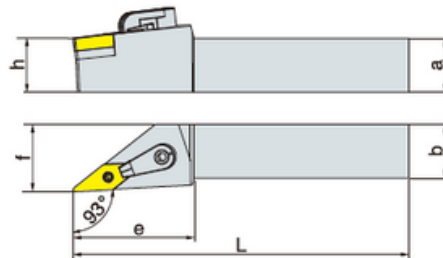
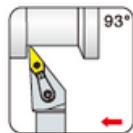

Cikkszám	Méret (mm)						Lapka	Alátét	Szorító csavar	Szorító	Csap	Csavarkulcs	Ár
	a	b	L	h	f	e							
ET-MVJNR/L1616H16	16	16	100	16	20	36	VN.1604..	MV1603	ML0625	HL2414	CTM513	L2.0\L3.0	€25
ET-MVJNR/L2020K16	20	20	125	20	25	36							€25
ET-MVJNR/L2525M16	25	25	150	25	32	42							€25
ET-MVJNR/L3232P16	32	32	170	32	40	42							€35

Szorítóköröm + alátétlapka + lapkacsavar + imbuszkulcs szett: €9

117.5° MVQNR/L (belső hűtés)

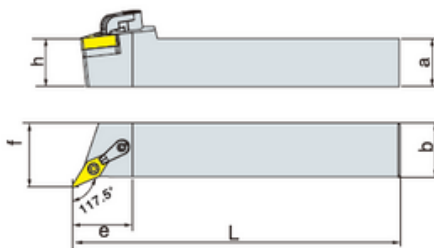
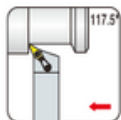

Cikkszám	Méret (mm)						Lapka	Alátét	Szorító csavar	Szorító	Csap	Csavarkulcs	Ár
	a	b	L	h	f	e							
ET-MVQNR/L2020K16	20	20	125	20	25	40	VN.1604..	MV1603	ML0625	HL2414	CTM513	L2.0\L3.0	€25
ET-MVQNR/L2525M16	25	25	150	25	32	40							€25
ET-MVQNR/L3232P16	32	32	170	32	40	40							€35

95° MVUNR/L (belső hűtés)

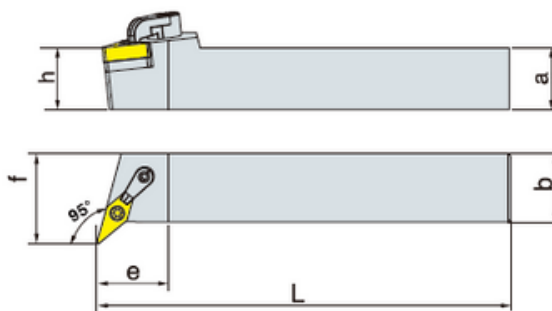
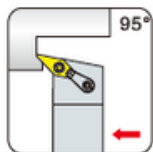

Cikkszám	Méret (mm)						Lapka	Alátét	Szorító csavar	Szorító	Csap	Csavarkulcs	Ár
	a	b	L	h	f	e							
ET-MVUNR/L2020K16	20	20	125	20	25	40	VN.1604..	MV1603	ML0625	HL1814	CTM513	L2.0\L3.0	€25
ET-MVUNR/L2525M16	25	25	150	25	32	40							€25

Szorítókörm + alátétlapka + lapkacsavar + imbuszkulcs szett: €9

72.5° MVVNN

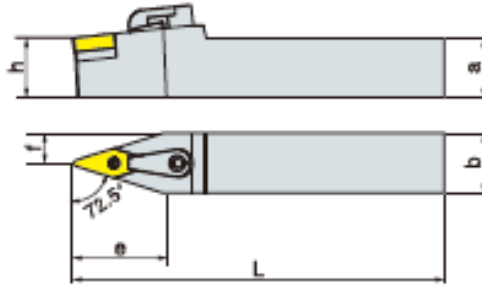
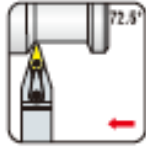

Cikkszám	Méret (mm)						Lapka	Alátét	Szorító csavar	Szorító	Csap	Csavarkulcs	Ár
	a	b	L	h	f	e							
ET-MVVNN2020K16	20	20	125	20	10	48	VN.1604..	MV1603	ML0625	HL2414	CTM513	L2.0\ L3.0	€25
ET-MVVNN2525M16	25	25	150	25	12.5	48							€25

95° MWLNR/L

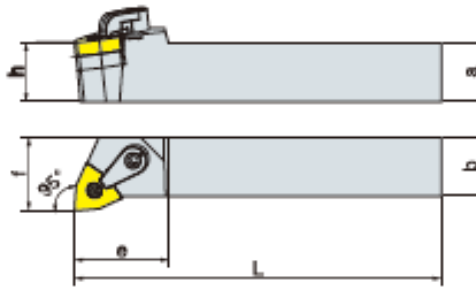
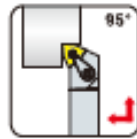

Cikkszám	Méret (mm)						Lapka	Alátét	Szorító csavar	Szorító	Csap	Csavarkulcs	Ár
	a	b	L	h	f	e							
ET-MWLNR/L1616H06	16	16	100	16	20	27	WN.0604..	MW0603	ML0625	HL1814	CTM513	L2.5\ L3.0	€25
ET-MWLNR/L2020K06	20	20	125	20	25	27							€25
ET-MWLNR/L2525M06	25	25	150	25	32	27							€25
ET-MWLNR/L1616H08	16	16	100	16	20	27	WN.0804..	MW0804	ML0625	HL1814	CTM617	L2.5\ L3.0	€25
ET-MWLNR/L2020K08	20	20	125	20	25	27							€25
ET-MWLNR/L2525M08	25	25	150	25	32	27							€25
ET-MWLNR/L3232P08	32	32	170	32	40	27							€35
ET-MWLNR/L4040R08	40	40	200	40	50	30							€35

Szorítókörm + alátétlapka + lapkacsavar + imbuszkulcs szett: €9

90° SCACR/L

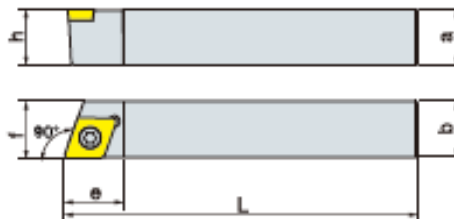
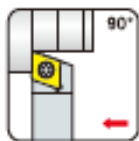

Cikkszám	Méret (mm)						Lapka	Csavar	Csavarkulcs	Ár
	a	b	L	h	f	e				
ET-SCACR/L0808F06	8	8	80	8	8	10	CC..0602..	M2.5X8	T-8	€25
ET-SCACR/L1010H06	10	10	100	10	10	10				€25
ET-SCACR/L1212H06	12	12	100	12	12	13				€25
ET-SCACR/L1212H09	12	12	100	12	12	13	CC..09T3..	M3.5X9	T-15	€25

75° SCBCR/L

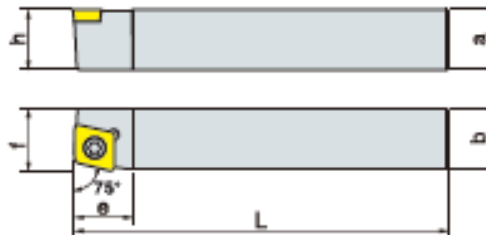
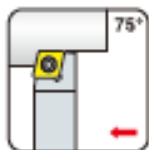

Cikkszám	Méret (mm)						Lapka	Csavar	Csavarkulcs	Ár
	a	b	L	h	f	e				
ET-SCBCR/L1212F06	12	12	80	12	12	13	CC..0602..	M2.5X8	T-8	€25
ET-SCBCR/L1616H06	16	16	100	16	16	13				€25
ET-SCBCR/L1212F09	12	12	80	12	12	13	CC..09T3..	M3.5X9	T-15	€25
ET-SCBCR/L1616H09	16	16	100	16	16	20				€25
ET-SCBCR/L2020K09	20	20	125	20	20	20				€25
ET-SCBCR/L2525M09	25	25	150	25	25	20				€25
ET-SCBCR/L2020K12	20	20	125	20	20	20	CC..1204..	M5X12	T-20	€25
ET-SCBCR/L2525M12	25	25	150	25	25	20				€25

Lapkacsavar + zászlókulcs szett €1

91° SCFCR/L

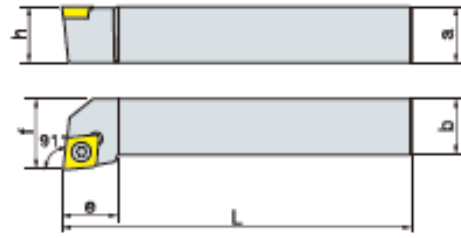
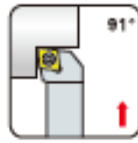

Cikkszám	Méret (mm)						Lapka	Csavar	Csavarkulcs	Ár
	a	b	L	h	f	e				
ET-SCFCR/L1010F06	10	10	100	10	12	11	CC..0602..	M2.5X8	T-8	€25
ET-SCFCR/L1212F06	12	12	100	12	16	16				€25
ET-SCFCR/L1616H09	16	16	100	16	20	16	CC..09T3..	M3.5X9	T-15	€25
ET-SCFCR/L2020K09	20	20	125	20	25	25				€25
ET-SCFCR/L2525M09	25	25	150	25	25	32				€25

75° SCKCR/L

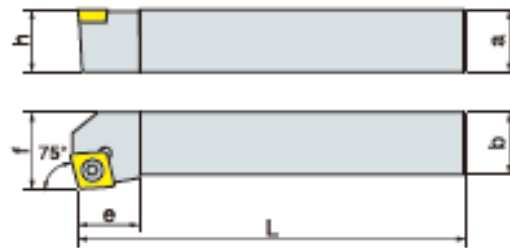
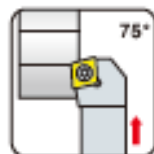

Cikkszám	Méret (mm)						Lapka	Csavar	Csavarkulcs	Ár
	a	b	L	h	f	e				
ET-SCKCR/L2020K09	20	20	125	20	25	23	CC..09T3..	M3.5X9	T-15	€25
ET-SCKCR/L2525M09	25	25	150	25	32	23				€25
ET-SCKCR/L2020K12	20	20	125	20	25	28	CC..1204..	M5X12	T-20	€25
ET-SCKCR/L2525M12	25	25	150	25	32	28				€25

Lapkacsavar + zászlókulcs szett €1

95° SCLCR/L (belső hűtés)

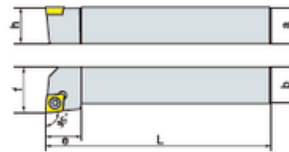

Cikkszám	Méret (mm)						Lapka	Csavar	Csavarkulcs	Ár
	a	b	L	h	f	e				
ET-SCLCR/L1010F06	10	10	100	10	12	12	CC.0602..	M2.5X8	T-8	€25
ET-SCLCR/L1212F09	12	12	100	12	16	16	CC.09T3..	M3.5X9	T-15	€25
ET-SCLCR/L1616H09	16	16	100	16	20	16				€25
ET-SCLCR/L2020K09	20	20	125	20	25	16				€25
ET-SCLCR/L2525M09	25	25	150	25	32	16				€25
ET-SCLCR/L2020K12	20	20	125	20	25	20				CC.1204..
ET-SCLCR/L2525M12	25	25	150	25	32	20	€25			
ET-SCLCR/L3232P12	32	32	170	32	40	20	€35			

40° SCMNCN-100

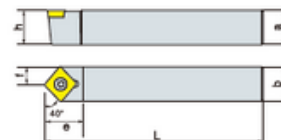

Cikkszám	Méret (mm)						Lapka	Csavar	Csavarkulcs	Ár
	a	b	L	h	f	e				
ET-SCMNCN1010F06-100	10	10	80	10	5	13	CC.0602..	M2.5X6	T-8	€25
ET-SCMNCN1212F09-100	12	12	80	12	6	18	CC.09T3..	M3.5X9	T-15	€25
ET-SCMNCN1616H09-100	16	16	100	16	8	18				€25
ET-SCMNCN2020K09-100	20	20	125	20	10	18				€25
ET-SCMNCN2525M09-100	25	25	150	25	12.5	18				€25
ET-SCMNCN2020K12-100	20	20	125	20	10	23				CC.1204..
ET-SCMNCN2525M12-100	25	25	150	25	12.5	23	€25			

Lapkacsavar + zászlókulcs szett €1

50° SCMCN

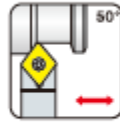

Cikkszám	Méret (mm)						Lapka	Csavar	Csavarkulcs	Ár
	a	b	L	h	f	e				
ET-SCMCN1010F06	10	10	80	10	5	13	CC..0602..	M2.5X6	T-8	€25
ET-SCMCN1212F09	12	12	80	12	6	18	CC..09T3..	M3.5X9	T-15	€25
ET-SCMCN1616H09	16	16	100	16	8	18				€25
ET-SCMCN2020K09	20	20	125	20	10	18				€25
ET-SCMCN2525M09	25	25	150	25	12.5	18				€25
ET-SCMCN2020K12	20	20	125	20	10	23				CC..1204..
ET-SCMCN2525M12	25	25	150	25	12.5	23	€25			

50° SCSCR/L

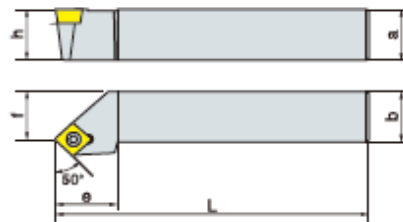

Cikkszám	Méret (mm)						Lapka	Csavar	Csavarkulcs	Ár
	a	b	L	h	f	e				
ET-SCSCR/L1212F06	12	12	80	12	16	18	CC..0602..	M2.5X6	T-8	€25
ET-SCSCR/L1616H06	16	16	100	16	20	18				€25

Lapkacsavar + zászlókulcs szett €1

90° SDACR/L

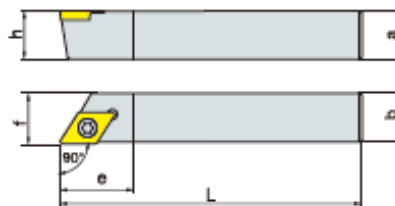

Cikkszám	Méret (mm)						Lapka	Csavar	Csavarkulcs	Ár
	a	b	L	h	f	e				
ET-SDACR/L0808F07	8	8	80	8	8	15	DC..0702..	M2.5X8	T-8	€25
ET-SDACR/L1010F07	10	10	80	10	10	15				€25
ET-SDACR/L1212F07	12	12	80	12	12	15				€25
ET-SDACR/L1212H11	12	12	100	12	12	22	DC..11T3..	M3.5X9	T-15	€25
ET-SDACR/L1616H11	16	16	125	16	16	22				€25
ET-SDACR/L2020K11	20	20	125	20	20	22				€25
ET-SDACR/L2525M11	25	25	150	25	25	22				€25

91° SDFCR/L

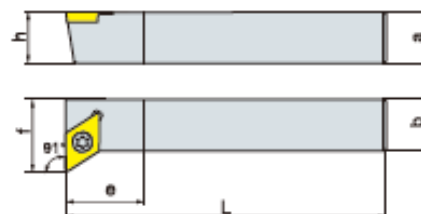

Cikkszám	Méret (mm)						Lapka	Csavar	Csavarkulcs	Ár
	a	b	L	h	f	e				
ET-SDFCR/L1212H07	12	12	100	12	16	8	DC..0702..	M2.5X8	T-8	€25
ET-SDFCR/L1212H11	12	12	100	12	18	14	DC..11T3..	M3.5X9	T-15	€25
ET-SDFCR/L1616H11	16	16	100	16	20	14				€25

Lapkacsavar + zászlókulcs szett €1

62.5° SDNCN

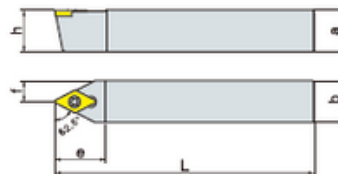

Cikkszám	Méret (mm)						Lapka	Csavar	Csavarkulcs	Ár
	a	b	L	h	f	e				
ET-SDNCN0808F07	8	8	125	8	4	14	DC..0702..	M2.5X8	T-8	€25
ET-SDNCN1010F07	10	10	125	10	5	14				€25
ET-SDNCN1212F07	12	12	125	12	6	14				€25
ET-SDNCN1212H11	12	12	100	12	6	21	DC..11T3..	M3.5X9	T-15	€25
ET-SDNCN1616H11	16	16	100	16	8	21				€25
ET-SDNCN2020K11	20	20	125	20	10	21				€25
ET-SDNCN2525M11	25	25	150	25	12.5	21				€25

107.5° SDQCR/L

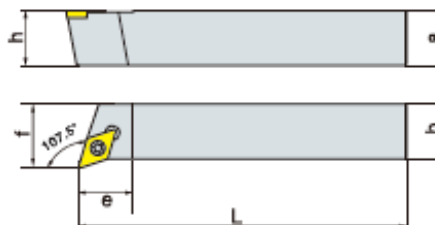

Cikkszám	Méret (mm)						Lapka	Csavar	Csavarkulcs	Ár
	a	b	L	h	f	e				
ET-SDQCR/L1010F07	10	10	100	10	12	5	DC..0702..	M2.5X8	T-8	€25
ET-SDQCR/L1212F07	12	12	100	12	16	13				€25
ET-SDQCR/L1212F11	12	12	100	12	16	14	DC..11T3..	M3.5X9	T-15	€25
ET-SDQCR/L1616H11	16	16	100	16	20	14				€25
ET-SDQCR/L2020K11	20	20	125	20	25	16				€25
ET-SDQCR/L2525M11	25	25	150	25	32	22				€25

Lapkacsavar + zászlókulcs szett €1

93° SDJCR/L

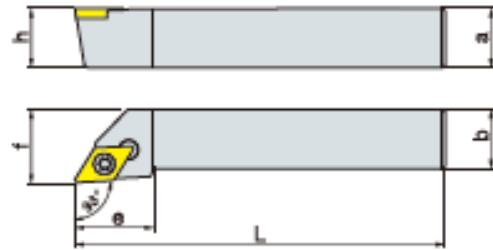

Cikkszám	Méret (mm)						Lapka	Csavar	Csavarkulcs	Ár
	a	b	L	h	f	e				
ET-SDJCR/L1010F07	10	10	80	10	12	14	DC..0702..	M2.5X8	T-8	€25
ET-SDJCR/L1212F07	12	12	80	12	16	14				€25
ET-SDJCR/L1616H07	16	16	100	16	20	14				€25
ET-SDJCR/L1212F11	12	12	80	12	16	20	DC..11T3..	M3.5X9	T-15	€25
ET-SDJCR/L1616H11	16	16	100	16	20	20				€25
ET-SDJCR/L2020K11	20	20	125	20	25	20				€25
ET-SDJCR/L2525M11	25	25	150	25	32	22				€25
ET-SDJCR/L3232P11	32	32	170	32	40	23				€35
ET-SDJCR/L4040R11	40	40	100	40	50	25				€35

93° SDJCR/L-F

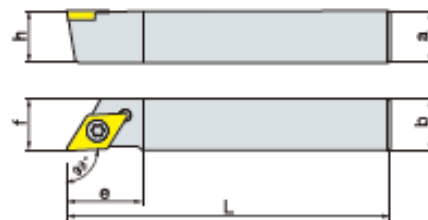

Cikkszám	Méret (mm)						Lapka	Csavar	Csavarkulcs	Ár
	a	b	L	h	f	e				
ET-SDJCR/L1212K11-F	12	12	80	12	16	20	DC..11T3..	M3.5X9	T-15	€25
ET-SDJCR/L1616K11-F	16	16	100	16	20	20				€25

Lapkacsavar + zászlókulcs szett €1

SRACR/L

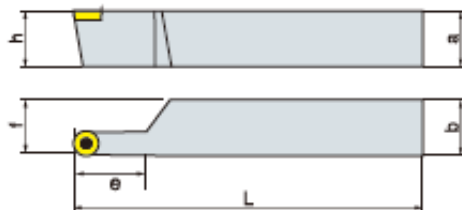
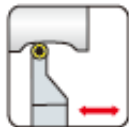

Cikkszám	Méret (mm)						Lapka	Csavar	Csavarkulcs	Ár
	a	b	L	h	f	e				
ET-SRACR/L1616H08	16	16	100	16	16.5	16	RC..0803..	M3X8	T-8	€25
ET-SRACR/L2020K08	20	20	125	20	20.5	20				€25
ET-SRACR/L2525M08	25	25	150	25	25.5	25				€25
ET-SRACR/L2020K10	20	20	125	20	20.4	20	RC..1003..	M3.5X9	T-15	€25
ET-SRACR/L2525M10	25	25	150	25	25.4	25				€25

SRDCN

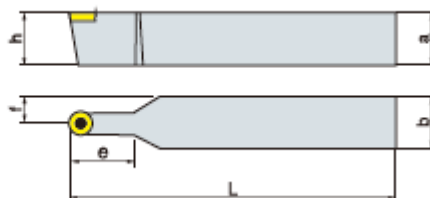

Cikkszám	Méret (mm)						Lapka	Csavar	Csavarkulcs	Ár
	a	b	L	h	f	e				
ET-SRDCN1616H08	16	16	100	16	8	16	RC..0803..	M3X8	T-10	€25
ET-SRDCN2020K08	20	20	125	20	10	16				€25
ET-SRDCN2525M08	25	25	150	25	12.5	16				€25
ET-SRDCN1616H10	16	16	100	16	8	20.3	RC..1003..	M3.5X9	T-15	€25
ET-SRDCN2020K10	20	20	125	20	10	20.3				€25
ET-SRDCN2525M10	25	25	150	25	12.5	20.3				€25

Lapkacsavar + zászlókulcs szett €1

SRGCR/L

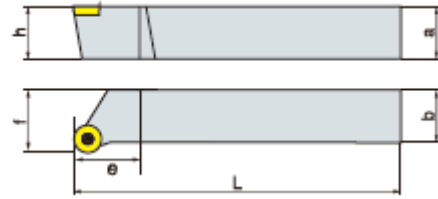
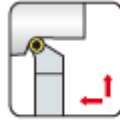

Cikkszám	Méret (mm)						Lapka	Csavar	Csavarkulcs	Ár
	a	b	L	h	f	e				
ET-SRGCR/L1616H08	16	16	100	16	20	20	RC..0803..	M3X8	T-8	€25
ET-SRGCR/L1616H10	16	16	100	16	20	20				€25
ET-SRGCR/L2020K10	20	20	125	20	25	20	RC..1003..	M3.5X9	T-15	€25
ET-SRGCR/L2525M10	25	25	150	25	32	25				€25

75° SSBCR/L

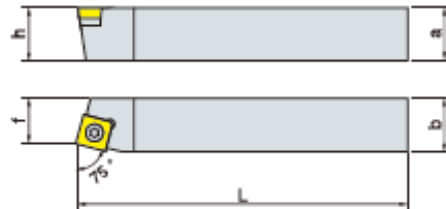
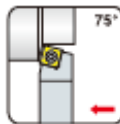

Cikkszám	Méret (mm)						Lapka	Csavar	Csavarkulcs	Ár
	a	b	L	h	f	e				
ET-SSBCR/L1212H09	12	12	80	12	9.5	18				€25
ET-SSBCR/L1616H09	16	16	100	16	12	18	SC..09T3..	M3.5X9	T-15	€25
ET-SSBCr/L2020K09	20	20	125	20	17	18				€25
ET-SSBCR/L2020K12	20	20	125	20	17	22				€25
ET-SSBCR/L2525M12	25	25	150	25	22	22	SC..1204..	M5X12	T-20	€25

Lapkacsavar + zászlóskulcs szett €1

45° SSDCN

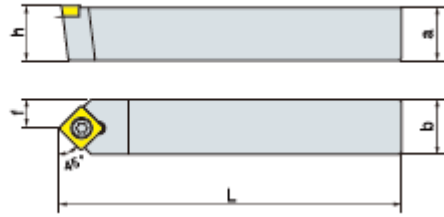
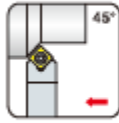

Cikkszám	Méret (mm)						Lapka	Csavar	Csavarkulcs	Ár
	a	b	L	h	f	e				
ET-SSDCN1212F09	12	12	100	12	6	16	SC..09T3..	M3.5X9	T-15	€25
ET-SSDCN1616H09	16	16	100	16	8	16				€25
ET-SSDCN2020K09	20	20	125	20	10	16				€25
ET-SSDCN2525M09	25	25	150	25	12.5	16				€25

75° SSKCR/L

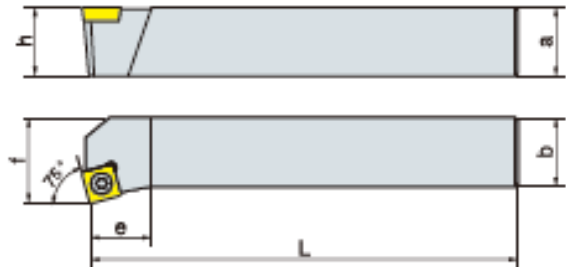
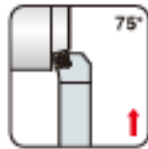

Cikkszám	Méret (mm)						Lapka	Csavar	Csavarkulcs	Ár
	a	b	L	h	f	e				
ET-SSKCR/L1212F09	12	12	80	12	16	16	SC..09T3..	M3.5X9	T-15	€25
ET-SSKCR/L1616H09	16	16	100	16	20	16				€25
ET-SSKCR/L2020K09	20	20	125	20	25	18				€25
ET-SSKCR/L2525M09	25	25	150	25	32	25				€25
ET-SSKCR/L2525M12	25	25	150	25	32	25	SC..1204..	M5X12	T-20	€25

Lapkacsavar + zászlókulcs szett €1

45° SSSCR/L

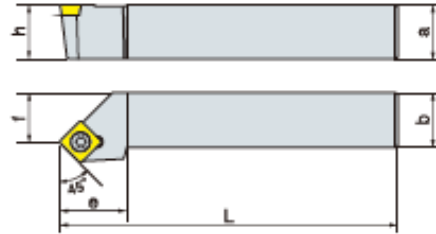
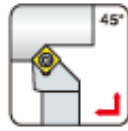

Cikkszám	Méret (mm)						Lapka	Csavar	Csavarkulcs	Ár
	a	b	L	h	f	e				
ET-SSSCR/L1212F09	12	12	80	12	16	16	SC.09T3..	M3.5X9	T-15	€25
ET-SSSCR/L1616H09	16	16	100	16	20	16				€25
ET-SSSCR/L2020K09	20	20	125	20	25	18				€25
ET-SSSCR/L2525M09	25	25	150	25	32	25				€25
ET-SSSCR/L2525M12	25	25	150	25	32	25	SC.1204..	M5X12	T-20	€25

91° STGCR/L

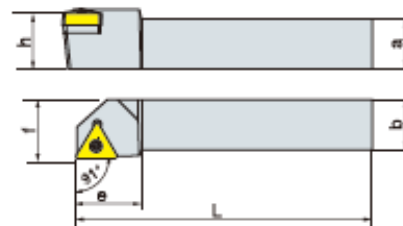

Cikkszám	Méret (mm)						Lapka	Csavar	Csavarkulcs	Ár
	a	b	L	h	f	e				
ET-STGCR/L1616H11	16	16	100	16	20	14	TC.1102..	M2.5X8	T-8	€25
ET-STGCR/L1616H16	16	16	100	16	20	14	TC.16T3..	M3.5X9	T-15	€25
ET-STGCR/L2020K16	20	20	125	20	25	20				€25
ET-STGCR/L2525M16	25	25	150	25	32	20				€25

Lapkacsavar + zászlóskulcs szett €1

91 ° STFCR/L (belső hűtés)

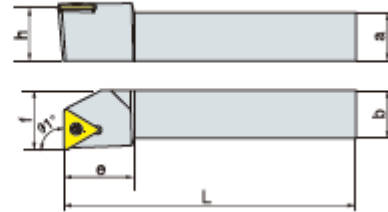
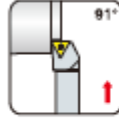

Cikkszám	Méret (mm)						Lapka	Csavar	Csavarkulcs	Ár
	a	b	L	h	f	e				
ET-STFCR/L1212F09	12	12	80	12	16	14	TC..0902..	M2.2X6	T-6	€25
ET-STFCR/L1212H11	12	12	80	12	16	14	TC..1102..	M2.5X8	T-8	€25
ET-STFCR/L1616H11	16	16	100	16	20	14				€25
ET-STFCR/L2020K16	20	20	125	20	25	22	TC..16T3..	M3.5X9	T-15	€25
ET-STFCR/L2525M16	25	25	150	25	32	22				€25
ET-STFCR/L3232P16	32	32	170	32	40	22				€35

93° STJCR/L

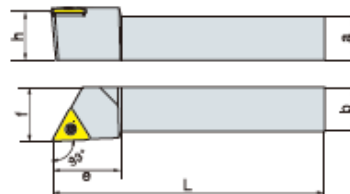
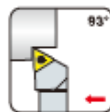

Cikkszám	Méret (mm)						Lapka	Csavar	Csavarkulcs	Ár
	a	b	L	h	f	e				
ET-STJCR/L1212F11	12	12	80	12	16	14	TC..1102..	M2.5X8	T-8	€25
ET-STJCR/L1616H11	16	16	100	16	20	14				€25

Lapkacsavar + zászlókulcs szett €1

60° STWCR/L

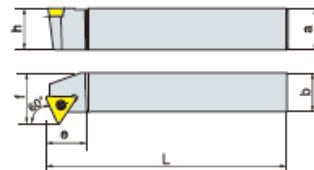

Cikkszám	Méret (mm)						Lapka	Csavar	Csavarkulcs	Ár
	a	b	L	h	f	e				
ET-STWCR/L1616H11	16	16	100	16	19.3	8	TC..1102..	M2.5X8	T-8	€25
ET-STWCR/L2020K11	20	20	125	20	23.3	8				€25
ET-STWCR/L2525M11	25	25	150	25	28.3	8				€25
ET-STWCR/L1616H16	16	16	100	16	21	12	TC..16T3..	M3.5X9	T-15	€25
ET-STWCR/L2020K16	20	20	125	20	26	12				€25
ET-STWCR/L2525M16	25	25	150	25	31	12				€25
ET-STWCR/L3232P16	32	32	170	32	38	12				€35

93° SVJBR/L 93° SVJCR/L

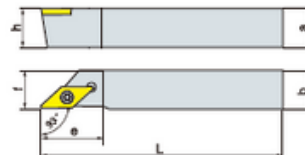

Cikkszám	Méret (mm)						Lapka	Csavar	Csavarkulcs	Ár
	a	b	L	h	f	e				
ET-SVJBR/L1616H16	16	16	100	16	20	32	VB..1604..	M3.5X9	T-15	€25
ET-SVJBR/L2020K16	20	20	125	20	25	32				€25
ET-SVJBR/L2525M16	25	25	150	25	32	32				€25
ET-SVJBR/L3232P16	32	32	170	32	40	40				€35
ET-SVJCR/L1616H16	16	16	100	16	20	32	VC..1604..	M3.5X9	T-15	€25
ET-SVJCR/L2020K16	20	20	125	20	25	32				€25
ET-SVJCR/L2525M16	25	25	150	25	32	32				€25
ET-SVJCR/L3232P16	32	32	170	32	40	40				€35

Lapkacsavar + zászlókulcs szett €1

117.5° SVQBR/L
117.5° SVQCR/L

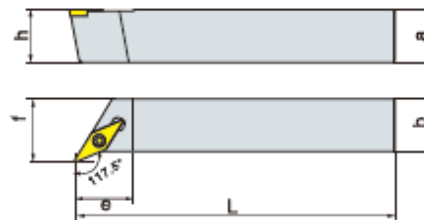
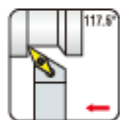

Cikkszám	Méret (mm)						Lapka	Csavar	Csavarkulcs	Ár
	a	b	L	h	f	e				
ET-SVQBR/L1616H11	16	16	100	16	20	32	VB.1103..	M2.5X8	T-8	€25
ET-SVQBR/L2020K11	20	20	125	20	25	32				€25
ET-SVQBR/L2525M11	25	25	150	25	32	32				€25
ET-SVQCR/L1616H16	16	16	100	16	20	32	VC.1604..	M3.5X9	T-15	€25
ET-SVQCR/L2020K16	20	20	125	20	25	32				€25
ET-SVQCR/L2525M16	25	25	150	25	32	32				€25
ET-SVQCR/L3232P16	32	32	170	32	40	40				€35

95° SVUBR/L
95° SVUCR/L

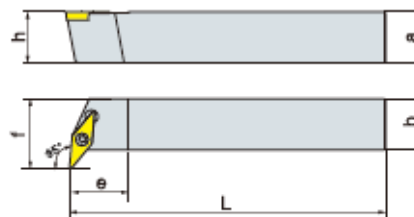
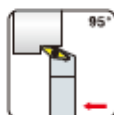

Cikkszám	Méret (mm)						Lapka	Csavar	Csavarkulcs	Ár
	a	b	L	h	f	e				
ET-SVUBR/L1212H11	12	12	100	12	20	14	VB.1103..	M2.5X8	T-8	€25
ET-SVUBR/L1616H11	16	16	100	16	20	14				€25
ET-SVUCR/L2020K16	20	20	125	20	30	18	VC.1604..	M3.5X9	T-15	€25
ET-SVUCR/L2525M16	25	25	150	25	35	18				€25

Lapkacsavar + zászlókulcs szett €1

72.5° SVVBN
72.5° SVVCN

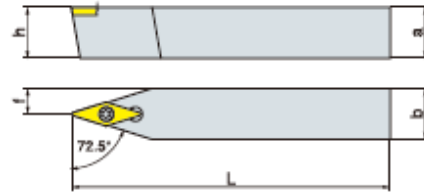
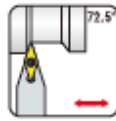

Cikkszám	Méret (mm)						Lapka	Csavar	Csavarkulcs	Ár
	a	b	L	h	f	e				
ET-SVVBN1212F11	12	12	80	12	6	24	VB.1103..	M2.5X8	T-8	€25
ET-SVVBN1616H11	16	16	100	16	8	24				€25
ET-SVVBN2020K11	20	20	125	20	10	24				€25
ET-SVVBN2525M11	25	25	150	25	12.5	24				€25
ET-SVVBN1616H16	16	16	100	16	8	34	VB.1604..	M3.5X9	T-15	€25
ET-SVVBN2020K16	20	20	125	20	10	34				€25
ET-SVVBN2525M16	25	25	150	25	12.5	34				€25
ET-SVVBN3232P16	32	32	150	32	16	34				€35
ET-SVVCN1212F11	12	12	80	12	6	24	VC.1103..	M2.5X8	T-8	€25
ET-SVVCN1616H11	16	16	100	16	8	24				€25
ET-SVVCN2020K11	20	20	125	20	10	24				€25
ET-SVVCN2525M11	25	25	150	25	12.5	24				€25
ET-SVVCN1616H16	16	16	100	16	8	34	VC.1604..	M3.5X9	T-15	€25
ET-SVVCN2020K16	20	20	125	20	10	34				€25
ET-SVVCN2525M16	25	25	150	25	12.5	34				€25
ET-SVVCN3232P16	32	32	150	32	16	34				€35

Lapkacsavar + zászlókulcs szett €1



ETALON

TOOLS



02. FURATKÉSEK

91° MCFNR/L



Cikkszám	Méret (mm)							Lapka	Alátét	Szorító csavar	Szorító	Csap	Csavarkulcs	Ár
	Dmin	D	f	L	L1	H	K							
ET-S20Q-MCFNR/L12	23	20	13	180	33	18	15	CN.1204..	X	ML0622	HL1812	CTM613	L2.5\L3.0	€35
ET-S25R-MCFNR/L12	29	25	17	200	47	23	13			ML0625	HL1814			€35

75° MCKNR/L

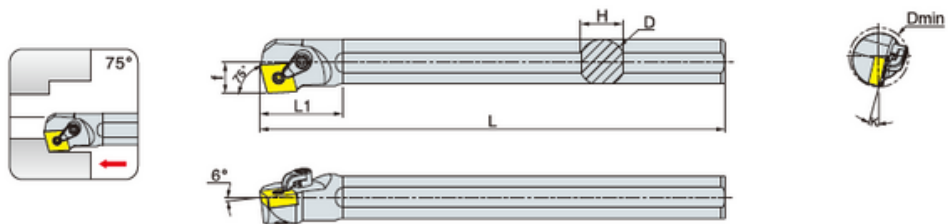

Cikkszám	Méret (mm)							Lapka	Alátét	Szorító csavar	Szorító	Csap	Csavarkulcs	Ár
	Dmin	D	f	L	L1	H	K							
ET-S20Q-MCKNR/L12	26	20	14	180	45	19	15	CN.1204..	X	ML0622	HL1812	CTM613	L2.5\L3.0	€35
ET-S25R-MCKNR/L12	32	25	17	200	45	24	12			ML0625	HL1814			€35
ET-S32S-MCKNR/L12	40	32	22.5	250	50	30	17	MC1204		ML0625	HL1814	CTM617	L2.5\L3.0	€35
ET-S40T-MCKNR/L12	50	40	27	300	55	38	15							€65
ET-S50U-MCKNR/L12	60	50	35	350	70	48	12							€180

95° MCLNR/L

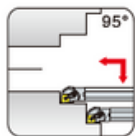

Cikkszám	Méret (mm)							Lapka	Alátét	Szorító csavar	Szorító	Csap	Csavarkulcs	Ár
	Dmin	D	f	L	L1	H	K							
ET-S20Q-MCLNR/L09	23	20	13	180	33	18	15	CN..0904..		ML0515	HL1511	CTM509	L2.0\L2.5	€35
ET-S20Q-MCLNR/L12	23	20	13	180	45	18	15	CN..1204..	X	ML0622	HL1812	CTM613	L2.5\L3.0	€35
ET-S25R-MCLNR/L12	30	25	17	200	45	23	12							€35
ET-S32S-MCLNR/L12	38	32	22.5	250	50	30	17							€35
ET-S40T-MCLNR/L12	47	40	27	300	55	38	15	CN..1204..	MC1204	ML0625	HL1814	CTM617	L2.5\L3.0	€65
ET-S45U-MCLNR/L12	55	45	29.5	350	65	43	15							€180
ET-S50U-MCLNR/L12	60	50	31	350	70	48	12							€180
ET-S60V-MCLNR/L12	70	60	36	400	70	58	10							€220
ET-S32S-MCLNR/L16	38	32	22.5	250	50	30	17							CN..1606..
ET-S40T-MCLNR/L16	47	40	27	300	55	38	15	€65						
ET-S50U-MCLNR/L19	60	50	31	350	75	48	12	CN..1906..	MC1904	ML0830	HL2217	CTM1022	L4.0	

50° MCWNR/L

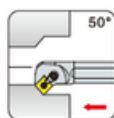

Cikkszám	Méret (mm)							Lapka	Alátét	Szorító csavar	Szorító	Csap	Csavarkulcs	Ár
	Dmin	D	f	L	L1	H	K							
ET-S20Q-MCWNR/L12	27	20	14	180	40	18	15	CN..1204..	X	ML0622	HL1812	CTM613	L2.5\L3.0	€35
ET-S25R-MCWNR/L12	31	25	17	200	45	23	12							€35
ET-S32S-MCWNR/L12	39	32	22.5	250	50	30	17							MC1204

107.5° MDQNR/L

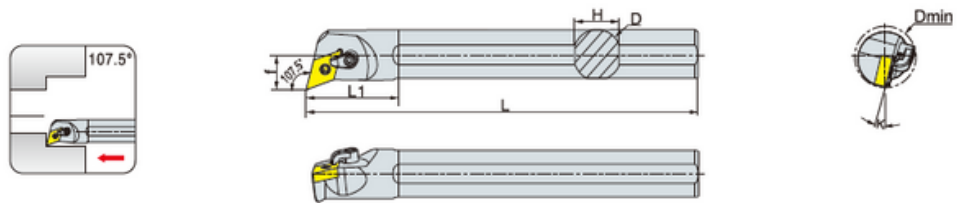

Cikkszám	Méret (mm)							Lapka	Alátét	Szorító csavar	Szorító	Csap	Csavarkulcs	Ár
	Dmin	D	f	L	L1	H	K							
ET-S25R-MDQNR/L15	32	25	17	200	45	23	12	DN.1504..	X	ML0625	HL2114	CTM613	L2.5\L3.0	€35
ET-S32S-MDQNR/L15	42	32	22.5	250	50	30	17	DN.1504.. DN.1506..	MD1506 MD1504			CTM617		€35
ET-S40T-MDQNR/L15	50	40	27	300	60	38	15					CTM617		€65
ET-S50U-MDQNR/L15	63	50	33	350	70	48	12					€180		

95° MDUNR/L

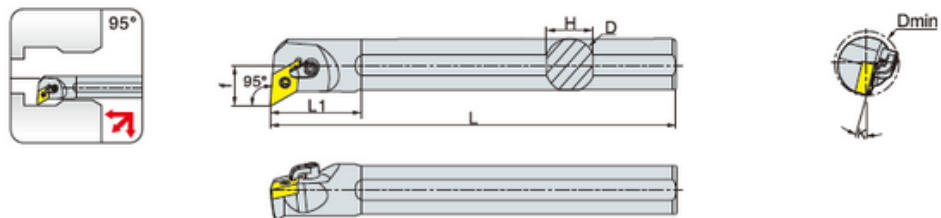

Cikkszám	Méret (mm)							Lapka	Alátét	Szorító csavar	Szorító	Csap	Csavarkulcs	Ár
	Dmin	D	f	L	L1	H	K							
ET-S25R-MDUNR/L11	30	25	17	180	45	23	12	DN.1104..	X	ML0625	HL2114	CTM510	L2.5\L3.0	€35
ET-S25R-MDUNR/L15	38	25	17	200	45	23	12	DN.1504..	X			CTM613		€35
ET-S32S-MDUNR/L15	47	32	22	250	50	30	17		MD1504			CTM617		€35
ET-S40T-MDUNR/L15	50	40	27	300	60	38	15					CTM617		€65
ET-S50U-MDUNR/L15	60	50	32	350	70	48	12					€180		

93° MDZNR/L

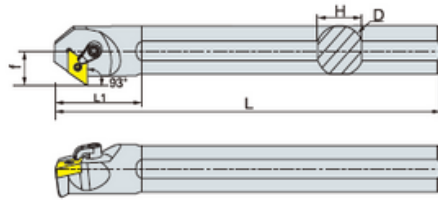
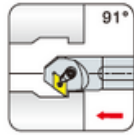

Cikkszám	Méret (mm)							Lapka	Alátét	Szorító csavar	Szorító	Csap	Csavarkulcs	Ár
	Dmin	D	f	L	L1	H	K							
ET-S25R-MDZNR/L15	32	25	18	200	45	23	13	DN.1504..	X	ML0622	HL2114	CTM613	L2.5\3.0	€35
ET-S32S-MDZNR/L15	38	32	22	250	50	30	17		MD1504	ML0625				CTM617
ET-S40T-MDZNR/L15	47	40	27	300	55	38	13				MD1504	ML0625	CTM617	
ET-SS0U-MDZNR/L15	60	50	33	350	70	48	12		MD1504	ML0625				CTM617

62.5° MDWNR/L

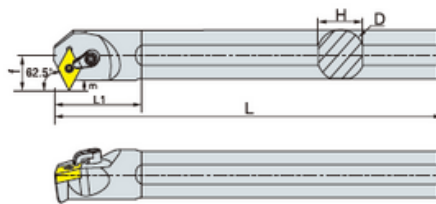
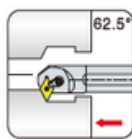

Cikkszám	Méret (mm)								Lapka	Alátét	Szorító csavar	Szorító	Csap	Csavarkulcs	Ár
	Dmin	D	f	L	L1	H	K	m							
ET-S25R-MDWNR/L15	34	25	22	200	45	23	13	9	DN.1504..	X	ML0625	HL2114	CTM613	L2.5\3.0	€35
ET-S32S-MDWNR/L15	41	32	25	250	50	30	17	8.5		MD1504					ML0625
ET-S40T-MDWNR/L15	47	40	29	300	55	38	13	8.5			MD1504	ML0625	HL2114	CTM617	
ET-SS0U-MDWNR/L15	60	50	32	350	70	48	12	6.5		MD1504					ML0625

75° MSKNR/L

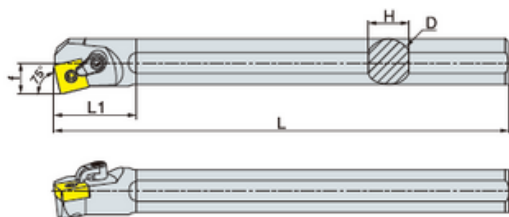
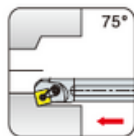

Cikkszám	Méret (mm)							Lapka	Alátét	Szorító csavar	Szorító	Csap	Csavarkulcs	Ár
	Dmin	D	f	L	L1	H	K							
ET-S20Q-MSKNR/L12	25	20	13	180	45	18	15	X	ML0622	HL1812	CTM613		€35	
ET-S25R-MSKNR/L12	30	25	17	200	45	23	12		ML0625	HL1814			€35	
ET-S32S-MSKNR/L12	38	32	22	250	50	30	17	SN..1204..	MS1204	ML0625	HL1814	CTM617	L2.5\3.0	€35
ET-S40T-MSKNR/L12	47	40	27	300	55	38	15	€65						
ET-S50U-MSKNR/L12	63	50	34	350	70	48	12	€180						

91° MTFNR/L

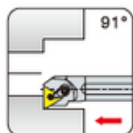

Cikkszám	Méret (mm)							Lapka	Alátét	Szorító csavar	Szorító	Csap	Csavarkulcs	Ár
	Dmin	D	f	L	L1	H	K							
ET-S20Q-MTFNR/L16	25	20	13	180	40	18	15	X	ML0622	HL1812	CTM510		€35	
ET-S25R-MTFNR/L16	30	25	17	200	45	23	12		ML0625	HL1814			€35	
ET-S32S-MTFNR/L16	38	32	22	250	54	30	17	TN..1604..	MT1603	HL1814	CTM513	L2.0\3.0	€35	
ET-S40T-MTFNR/L16	47	40	27	300	60	38	15	€65						
ET-S50U-MTFNR/L16	60	50	31	350	65	48	12	€180						
ET-S40T-MTFNR/L22	50	40	27	300	55	38	15	TN..2204..	MT2204	ML0830	HL1917	CTM617	L2.0\4.0	€65
ET-S50U-MTFNR/L22	60	50	31	350	70	48	12						€180	

95° MTUNR/L

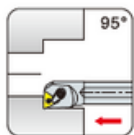

Cikkszám	Méret (mm)							Lapka	Alátét	Szorító csavar	Szorító	Csap	Csavarkulcs	Ár
	Dmin	D	f	L	L1	H	K							
ET-S20Q-MTUNR/L16	25	20	13	180	42	18	15	TN.1604..	X	MLO622	HL1812	CTM510		€35
ET-S25R-MTUNR/L16	30	25	17	200	45	23	12							€35
ET-S32S-MTUNR/L16	38	32	22	250	54	30	17		MTI603	MLO625	HL1814	CTM513	L2.0 \ L3.0	€35
ET-S40T-MTUNR/L16	47	40	27	300	60	38	15							€65
ET-S50U-MTUNR/L16	60	50	31	350	65	48	12							€180
ET-S40T-MTUNR/L22	47	40	27	300	55	38	15	TN.2204..	MT2204	MLO830	HL1917	CTM617	L2.5 \ L4.0	€65
ET-S50U-MTUNR/L22	60	50	31	350	70	48	12							€180

117° MTJNR/L

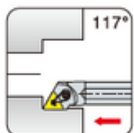

Cikkszám	Méret (mm)							Lapka	Alátét	Szorító csavar	Szorító	Csap	Csavarkulcs	Ár
	Dmin	D	f	L	L1	H	K							
ET-S25R-MTJNR/L16	30	25	17	200	45	23	12	TN.1604..	MTI603	MLO625	HL1814	CTM510	L2.0 \ L3.0	€35
ET-S32S-MTJNR/L16	38	32	22	250	54	30	17							CTM513

60° MTWNR/L

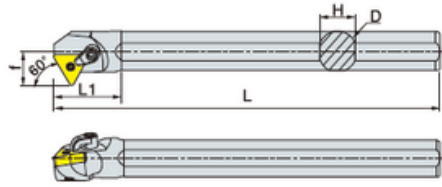
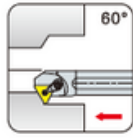

Cikkszám	Méret (mm)							Lapka	Alátét	Szorító csavar	Szorító	Csap	Csavarkulcs	Ár
	Dmin	D	f	L	L1	H	K							
ET-S20Q-MTWNR/L16	25	20	14	180	40	18	15	TN..1604..	X	ML0622	HL1812	CTM510	L2.0/L3.0	€35
ET-S25R-MTWNR/L16	30	25	17	200	45	23	12			ML0625	HL1814			€35
ET-S32S-MTWNR/L16	38	32	22	250	54	30	17		MTI603	ML0625	HL1814	CTM513		€35
ET-S40T-MTWNR/L16	47	40	27	300	60	38	15							€65
ET-S50U-MTWNR/L16	60	50	31	350	65	48	12							€180

105° MTQNR/L

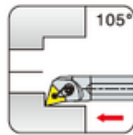

Cikkszám	Méret (mm)							Lapka	Alátét	Szorító csavar	Szorító	Csap	Csavarkulcs	Ár
	Dmin	D	f	L	L1	H	K							
ET-S20Q-MTQNR/L16	25	20	14	180	40	18	15	TN..1604..	X	ML0622	HL1812	CTM510	L2.0/L3.0	€35
ET-S25R-MTQNR/L16	30	25	17	200	45	23	12			ML0625	HL1814			€35
ET-S32S-MTQNR/L16	38	32	22	250	54	30	17		MTI603	ML0625	HL1814	CTM513		€35
ET-S40T-MTQNR/L16	47	40	27	300	60	38	15							€65
ET-S50U-MTQNR/L16	60	50	31	350	65	48	12							€180

117.5° MVQNR/L (belső hűtés)

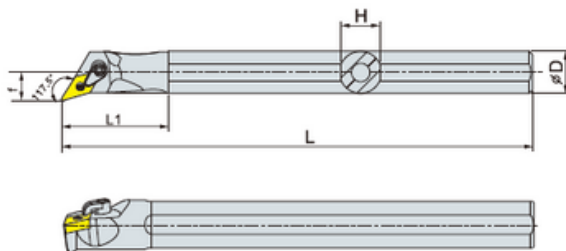
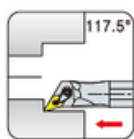

Cikkszám	Méret (mm)							Lapka	Alátét	Szorító csavar	Szorító	Csap	Csavarkulcs	Ár
	Dmin	D	f	L	L1	H	K							
ET-S25R-MVQNR/L16	30	25	17	200	45	23	12	VN.1604..	X	MLO625	HL2114	CTM510	L2.0\L3.0	€35
ET-S32S-MVQNR/L16	38	32	23	250	50	30	17		€35					
ET-S40T-MVQNR/L16	47	40	27	300	55	38	15		MV1603			CTM513		€65
ET-S50U-MVQNR/L16	63	50	31	350	70	48	12		€180					

95° MVUNR/L (belső hűtés)

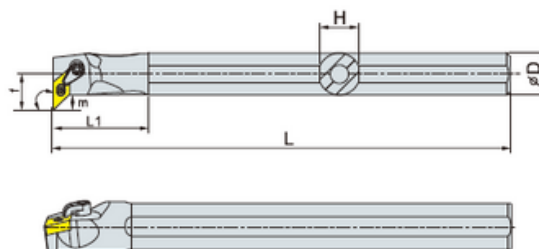
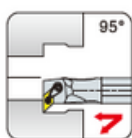

Cikkszám	Méret (mm)								Lapka	Alátét	Szorító csavar	Szorító	Csap	Csavarkulcs	Ár
	Dmin	D	f	L	L1	H	m	K							
ET-S25R-MVUNR/L16	32	25	20	200	45	23	7	12	VN.1604..	X	MLO625	HL2414	CTM510	L2.0\L3.0	€35
ET-S32S-MVUNR/L16	38	32	22	250	50	30	5.5	17		€35					
ET-S40T-MVUNR/L16	47	40	27	300	55	38	6.5	15		MV1603			CTM513		€65
ET-S50U-MVUNR/L16	63	50	31	350	70	48	5.5	12		€180					

72.5° MVWNR/L (belső hűtés)

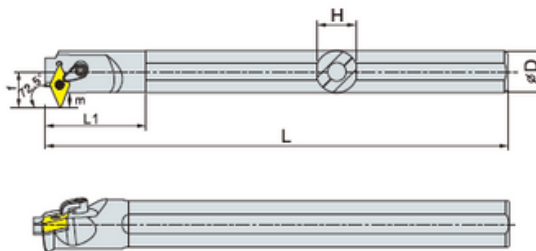
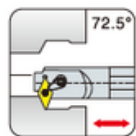

Cikkszám	Méret (mm)								Lapka	Alátét	Szorító csavar	Szorító	Csap	Csavarkulcs	Ár
	Dmin	D	f	L	L1	H	m	K							
ET-S25R-MVWNR/L16	35	25	23	200	45	23	10	13	VN.1604..	X	ML0622	HL2414	CTM510	L2.0 \ L3.0	€35
ET-S32S-MVWNR/L16	42	32	26	250	50	30	9.5	13		MV1603	ML0625		CTM513		€35

96° MVXNR/L (belső hűtés)

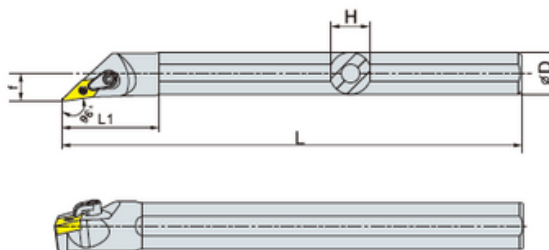
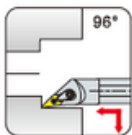

Cikkszám	Méret (mm)								Lapka	Alátét	Szorító csavar	Szorító	Csap	Csavarkulcs	Ár
	Dmin	D	f	L	L1	H	K								
ET-S20Q-MVXNR/L16	24	20	14	180	45	18	15	VN.1604..	X	ML0622	HL2412	CTM510	L2.0 \ L3.0	€35	
ET-S25R-MVXNR/L16	30	25	17	200	50	23	12							€35	
ET-S32S-MVXNR/L16	38	32	22	250	55	30	17		MV1603	ML0625	HL2414	CTM513		€35	
ET-S40T-MVXNR/L16	47	40	27	300	60	38	15							€65	
ET-S50U-MVXNR/L16	60	50	31	350	65	48	12		€180						

SCKCR/L

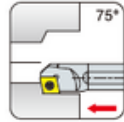

Cikkszám	Méret (mm)							Lapka	Csavar	Csavarkulcs	Ár
	Dmin	D	f	L	L1	H	K				
ET-S08K-SCKCR/L06	10	8	5.5	125	21	7	13	CC..0602..	M2.5X5	T-18	€35
ET-S10K-SCKCR/L06	11	10	6	125	25	9	12		M2.5X6		€35
ET-S12M-SCKCR/L06	13	12	7	150	25	11	10		€35		
ET-S12M-SCKCR/L09	14	12	8	150	30	11	12	CC..09T3..	M3.5X9	T-15	€35
ET-S16N-SCKCR/L09	17	16	9.5	180	36	15	10				€35
ET-S20Q-SCKCR/L09	21	20	11.5	180	38	18	8				€35
ET-S25R-SCKCR/L12	27	26	15	200	42	23	6	CC..1204..	M5X12	T-20	€35

SCLCR/L (belső hűtés)

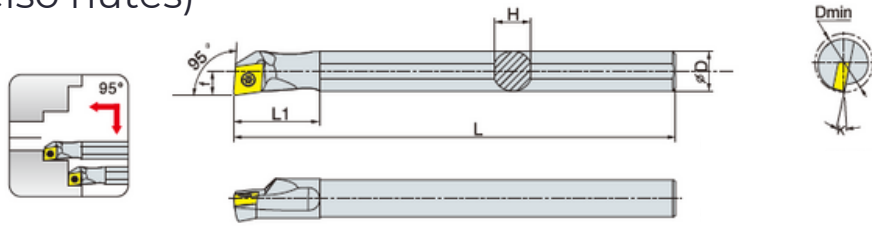

Cikkszám	Méret (mm)							Lapka	Csavar	Csavarkulcs	Ár
	Dmin	D	f	L	L1	H	K				
ET-S07K-SCLCR/L06	8	8	5	125	18	7	15	CC..0602..	M2.5X5	T-18	€35
ET-S08K-SCLCR/L06	9	8	5.5	125	18	7	13				€35
ET-S08K-SCLCR/L06-A16	9	16	5	125	24	15	13				€35
ET-S10K-SCLCR/L06	11	10	7	125	22	9	12				€35
ET-S10K-SCLCR/L06-A16	11	16	6	125	30	15	12				€35
ET-S12M-SCLCR/L06	13	12	8	150	25	11	10				M2.5X6
ET-S12M-SCLCR/L09	16	14	5.5	150	27	13	10	CC..09T3..	M3.5X9	T-15	€35
ET-S14M-SCLCR/L09	15	12	8	150	27	11	12				€35
ET-S16Q-SCLCR/L09	17	16	11	180	34	15	10				€35
ET-S20Q-SCLCR/L09	21	20	13	180	38	18	8				€35
ET-S25R-SCLCR/L09	26	25	17	200	45	23	6				€35
ET-S32S-SCLCR/L09	33	32	22	250	45	30	4				€35
ET-S20Q-SCLCR/L12	21	20	13	180	42	18	8	CC..1204..	M5X12	T-20	€35
ET-S25R-SCLCR/L12	26	25	17	200	45	23	8				€35
ET-S32S-SCLCR/L12	33	32	22	250	45	30	6				€35
ET-S40T-SCLCR/L12	41	40	27	300	48	38	4				€65

93° SCZCR/L

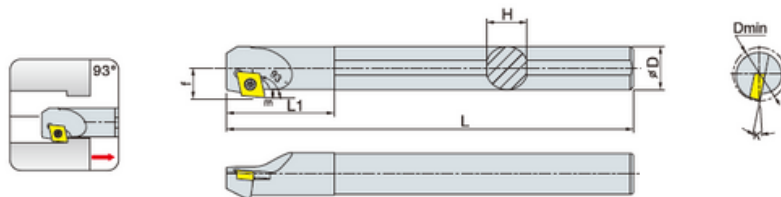

Cikkszám	Méret (mm)								Lapka	Csavar	Csavarkulcs	Ár
	Dmin	D	f	L	L1	H	m	K				
ET-S08K-SCZCR/L06	10	8	6.5	125	25	7	2.2	13	CC..0602..	M2.5X5	T-6	€35
ET-S10K-SCZCR/L06	12	10	7.5	125	27	9	2.2	12				€35
ET-S12M-SCZCR/L06	14	12	8.5	150	32	11	2.2	10		M2.5X6	T-8	€35
ET-S16Q-SCZCR/L06	18	16	10.5	180	30	15	2.2	8				€35
ET-S16Q-SCZCR/L09	21	16	13	180	35	15	4.5	10	CC..09T3..	M3.5X9	T-15	€35
ET-S20Q-SCZCR/L09	25	20	15	180	40	18	4.5	8				€35
ET-S25R-SCZCR/L09	32	26	18	200	42	23	5	6				€35

107.5° SDQCR/L

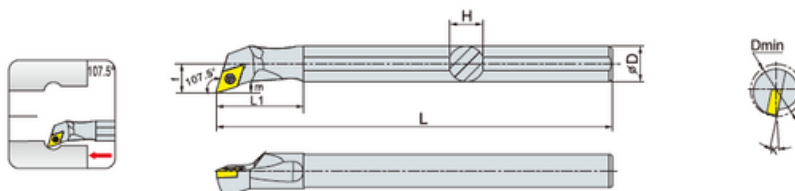

Cikkszám	Méret (mm)								Lapka	Csavar	Csavarkulcs	Ár
	Dmin	D	f	L	L1	H	m	K				
ET-S08K-SDQCR/L07	10	7	6	125	18	7	1.7	12	DC..0702..	M2.5X5	T-8	€35
ET-S10K-SDQCR/L07	11	10	7	125	24	9	1.7	10				€35
ET-S12M-SDQCR/L07	15	12	9	150	30	11	2.7	8		M2.5X6	T-8	€35
ET-S16Q-SDQCR/L07	17	16	11	180	30	15	2.7	6				€35
ET-S20Q-SDQCR/L11	23	20	13	180	42	18	2.7	5	DC..11T3..	M3.5X9	T-15	€35
ET-S25R-SDQCR/L11	29	25	17	200	42.5	23	4	4				€35
ET-S32S-SDQCR/L11	40	32	22	250	45	30	5.5	4				€35

95° SDUCR/L

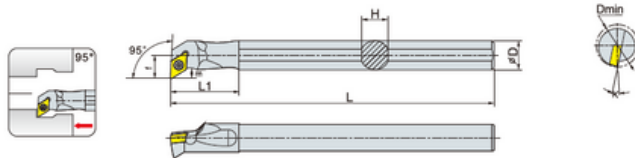

Cikkszám	Méret (mm)								Lapka	Csavar	Csavarkulcs	Ár
	Dmin	D	f	L	L1	H	m	K				
ET-S10K-SDUCR/L07	15	10	8	125	25	9	2.7	10	DC..0702..	M2.5X5	T-8	€35
ET-S12M-SDUCR/L07	17	12	9	150	25	11	2.7	8		M2.5X6		€35
ET-S16Q-SDUCR/L07	22	16	11	180	30	15	2.7	6		€35		
ET-S16Q-SDUCR/L11	19	16	11	180	34	15	2.7	8	DC..11T3..	M3.5X9	T-15	€35
ET-S20Q-SDUCR/L11	23	20	13	180	40	18	2.7	6				€35
ET-S25R-SDUCR/L11	29	25	17	200	42	23	4	5				€35
ET-S32S-SDUCR/L11	38	32	22	250	45	30	5.5	4				€35
ET-S40T-SDUCR/L11	45	40	25	300	50	38	4.5	4				€65
ET-S50U-SDUCR/L11	60	50	31	350	55	48	5.5	0				€180

62.5° SDWCR/L

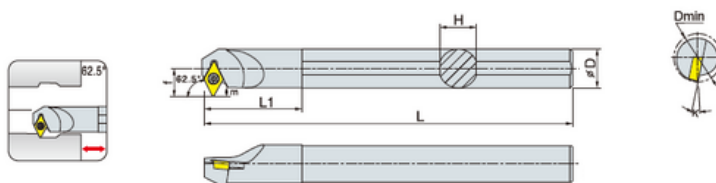

Cikkszám	Méret (mm)								Lapka	Csavar	Csavarkulcs	Ár
	Dmin	D	f	L	L1	H	m	K				
ET-S12M-SDWCR/L07	16	12	10.5	150	25	11	4.2	10	DC..0702..	M2.5X5	T-8	€35
ET-S16Q-SDWCR/L07	20	16	12.5	180	34.5	15	4.2	8		M2.5X6		€35
ET-S20Q-SDWCR/L07	27	20	14.5	180	30	18	4.2	6		€35		
ET-S20Q-SDWCR/L11	24	20	14.5	180	40	18	4.2	6	DC..11T3..	M3.5X9	T-15	€35
ET-S25R-SDWCR/L11	29	25	17	200	45	23	4.2	5				€35
ET-S32S-SDWCR/L11	40	32	22	250	45	30	5.5	2				€35

93° SDZCR/L

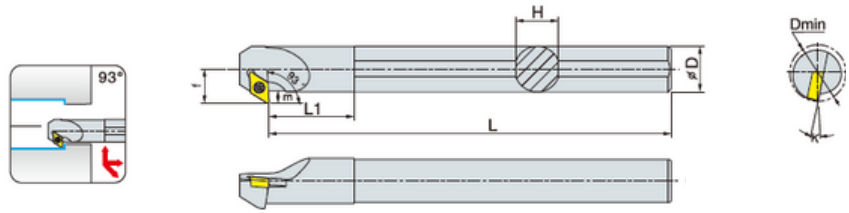

Cikkszám	Méret (mm)								Lapka	Csavar	Csavarkulcs	Ár
	Dmin	D	f	L	L1	H	m	K				
ET-S10K-SDZCR/L07	13	10	8.5	125	22	9	12	3.2	DC..0702..	M2.5X5	T-8	€35
ET-S12M-SDZCR/L07	16	12	10	150	31	11	10	3.5				€35
ET-S16Q-SDZCR/L07	21	16	13	180	37	15	6	4.5		M2.5X8		€35
ET-S20Q-SDZCR/L07	24	20	14.5	180	47	18	6	4.2				€35
ET-S20Q-SDZCR/L11	25	20	15	180	50	10	8	4.5	DC..11T3..	M3.5X9	T-15	€35
ET-S25R-SDZCR/L11	29	25	17	202	45	23	6	4.2				€35
ET-S32S-SDZCR/L11	38	32	22	250	56	30	4	5.5				€35

75° SSKCR/L

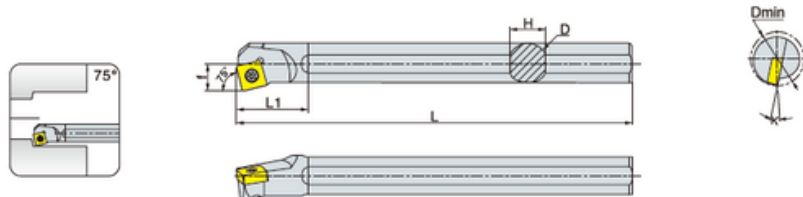

Cikkszám	Méret (mm)								Lapka	Csavar	Csavarkulcs	Ár
	Dmin	D	f	L	L1	H	K					
ET-S12M-SSKCR/L09	16	12	8.5	150	30	11	12	SC..09T3..	M3.5X9	T-15	€35	
ET-S16N-SSKCR/L09	18	16	11.5	180	32.6	15	10				€35	
ET-S20Q-SSKCR/L09	23	20	13	180	40	18	8				€35	
ET-S25R-SSKCR/L09	31	25	17	200	40	23	6				€35	

45° SSSCR/L

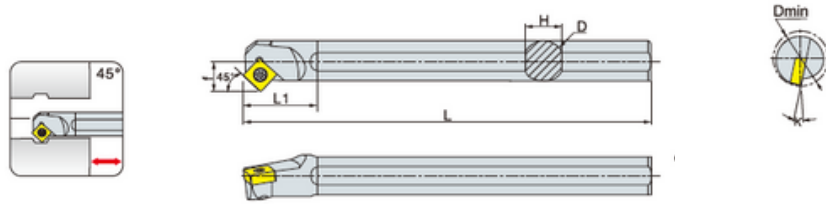

Cikkszám	Méret (mm)							Lapka	Csavar	Csavarkulcs	Ár
	Dmin	D	f	L	L1	H	K				
ET-S12M-SSSCR/L09	15	12	9	150	32	11	12	SC.09T3..	M3.5X9	T-15	€35
ET-S16Q-SSSCR/L09	19	16	11.5	180	32	15	10				€35
ET-S20Q-SSSCR/L09	27	20	13.5	180	40	18	8				€35
ET-S25R-SSSCR/L09	27	25	15	200	40	23	6				€35
ET-S32S-SSSCR/L09	38	32	22	250	46	30	6				€35

45° SSSPR/L

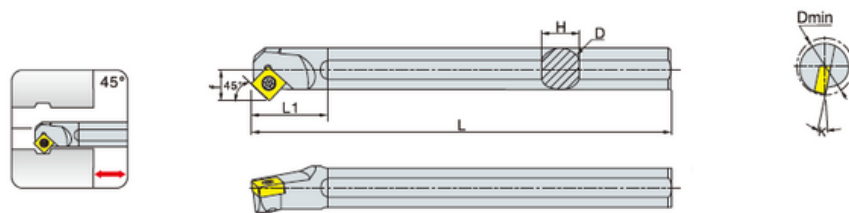

Cikkszám	Méret (mm)							Lapka	Csavar	Csavarkulcs	Ár
	Dmin	D	f	L	L1	H	K				
ET-S12M-SSSPR/L09	16	12	9	150	30	11	8	SP.09T3..	M3.5X9	T-15	€35
ET-S16Q-SSSPR/L09	20	16	11	180	35	15	6				€35
ET-S20Q-SSSPR/L09	24	20	13	180	40	18	4				€35
ET-S25R-SSSPR/L09	32	25	17	200	40	23	4				€35
ET-S32S-SSSPR/L09	40	32	22	250	45	30	0				€35

91° STFCL/L (belső hűtés)

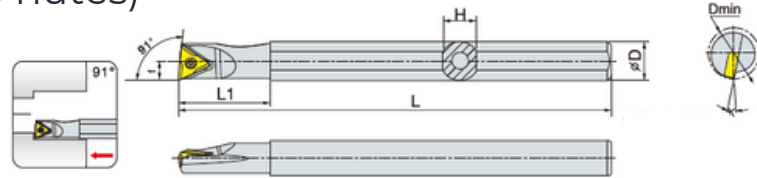

Cikkszám	Méret (mm)							Lapka	Csavar	Csavarkulcs	Ár	
	Dmin	D	f	L	L1	H	K					
ET-S08K-STFCL/L09	9	8	5.5	125	20	7	15	TC..0902..	M2.2X5	T-6	€35	
ET-S10K-STFCL/L09	11	10	6	125	24	9	13				€35	
ET-S12M-STFCL/L09	13	12	7	150	27	11	10				€35	
ET-S10K-STFCL/L11	11	10	6	125	24	9	12	TC..1102..	M2.5X6	T-8	€35	
ET-S12M-STFCL/L11	13	12	7	150	26	11	10				€35	
ET-S16Q-STFCL/L11	17	16	9	180	32	15	8				M2.5X8	€35
ET-S20Q-STFCL/L11	21	20	11	180	40	18	6					€35
ET-S20Q-STFCL/L16	22	20	11.5	180	42	18	8	TC..16T3..	M3.5X9	T-15	€35	
ET-S25R-STFCL/L16	26	25	14	200	42	23	6				€35	
ET-S32S-STFCL/L16	33	32	17.5	250	45	30	6				€35	
ET-S40T-STFCL/L16	43	40	23.5	300	60	38	4				€65	
ET-S50U-STFCL/L16	51	50	26.5	350	65	48	4				€180	

91° STFPR/L (belső hűtés)

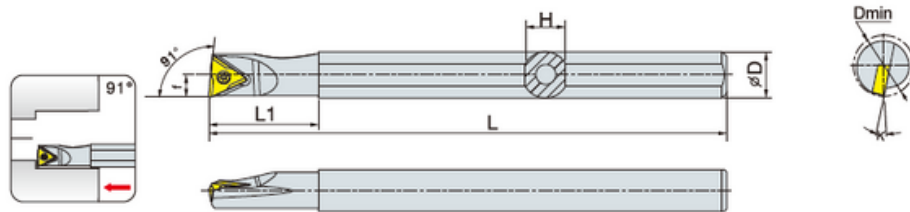

Cikkszám	Méret (mm)							Lapka	Csavar	Csavarkulcs	Ár
	Dmin	D	f	L	L1	H	K				
ET-S08K-STFPR/L09	9	8	5	125	20	7	10	TP..0902..	M2.5X6	T-8	€35
ET-S10K-STFPR/L09	11	10	6	125	22	9	13				€35
ET-S10K-STFPR/L1103	11	10	6	125	22	9	12	TP..1103..	M3X6	T-10	€35
ET-S12M-STFPR/L1103	12	12	7	150	24	11	10				€35
ET-S16Q-STFPR/L1103	17	16	9	180	30	15	8		M3X8		€35
ET-S20Q-STFPR/L1103	21	20	11	180	37	18	6				€35
ET-S20Q-STFPR/L16	21	20	11	180	42	18	8		TP..1603..		M3.5X9
ET-S25R-STFPR/L16	26	25	14	200	42	23	6	€35			

95° STUCR/L

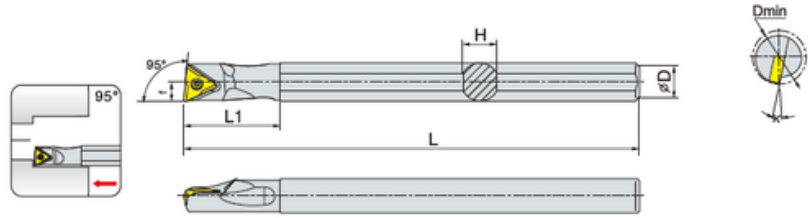

Cikkszám	Méret (mm)							Lapka	Csavar	Csavarkulcs	Ár
	Dmin	D	f	L	L1	H	K				
ET-S08K-STUCR/L09	9	8	5.5	125	20	7	15	TC..0902..	M2.5X5	T-8	€35
ET-S08K-STUCR/L09-A16	9	16	5.5	125	30	15	15				€35
ET-S10K-STUCR/L09	11	10	6.5	125	22	9	13				€35
ET-S10K-STUCR/L09-A16	11	16	6.5	125	30	15	13				€35
ET-S10K-STUCR/L11	11	10	6	125	24	9	12	TC..1102..	M2.5X5	T-8	€35
ET-S10K-STUCR/L11-A16	11	16	6	125	30	15	12				€35
ET-S12M-STUCR/L11	13	12	7	150	27	11	10				€35
ET-S12M-STUCR/L11-A16	13	16	7	150	30	15	10				€35
ET-S16Q-STUCR/L11	17	16	9	180	32	15	8	TC..1102..	M2.5X6	T-8	€35
ET-S20Q-STUCR/L11	21	20	11	180	37	18	6				€35
ET-S25R-STUCR/L11	26	25	14	200	42	23	6				€35
ET-S16Q-STUCR/L11	17	16	9	180	32	15	8				M2.5X8
ET-S20Q-STUCR/L16	23	20	13	180	42	18	7	TC..16T3	M3.5X9	T-15	€35
ET-S25R-STUCR/L16	26	25	14	200	45	23	6				€35
ET-S32S-STUCR/L16	33	32	17.5	250	47	30	4				€35
ET-S40T-STUCR/L16	42	40	22	300	55	38	4				€65
ET-S50U-STUCR/L16	51	50	26.5	350	65	48	4				€180

95° STUPR/L (belső hűtés)

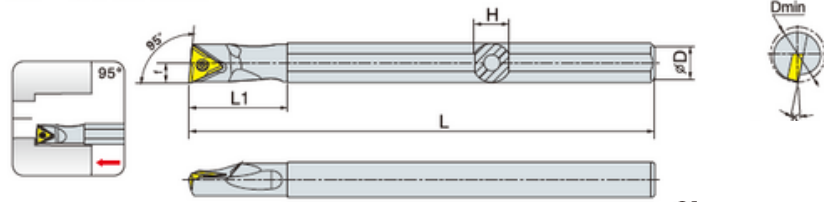

Cikkszám	Méret (mm)							Lapka	Csavar	Csavarkulcs	Ár	
	Dmin	D	f	L	L1	H	K					
ET-S0BK-STUPR/L09	9	5.5	6	125	20	7	10	TP..0902..	M2.5X5	T-8	€35	
ET-S10K-STUPR/L09	11	6.5	7	125	22	9	13				€35	
ET-S10K-STUPR/L1103	11	10	6	125	22	9	12	TP..1103..	M3X6	T-8	€35	
ET-S12M-STUPR/L1103	13	12	7	150	27	11	10				€35	
ET-S16N-STUPR/L1103	17	16	9	180	32	15	8				€35	
ET-S20Q-STUPR/L1103	21	20	11	180	37	18	6				M3X8	€35
ET-S20Q-STUPR/L16	24	20	13	180	40	18	4				€35	
ET-S25R-STUPR/L16	21	25	17	200	40	23	2	TP..1603..	M3.5X9	T-15	€35	
ET-S32S-STUPR/L16	39	32	22	250	45	32	0				€35	
ET-S40T-STUPR/L16	50	40	27	300	55	38	0				€65	
ET-S40T-STUPR/L16	50	40	27	300	55	38	0				€65	
ET-S50U-STUPR/L16	60	50	31	350	60	48	0				€180	

60° STWCR/L

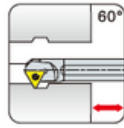

Cikkszám	Méret (mm)								Lapka	Csavar	Csavarkulcs	Ár
	Dmin	D	f	L	L1	H	K	m				
ET-S08K-STWCR/L09	11	8	6	125	25	7	12	1.7	TC..0902..	M2.5X5	T-8	€35
ET-S10K-STWCR/L11	13	10	8	125	23	9	10	2.7	TC..1102..	M2.5X6	T-8	€35
ET-S12M-STWCR/L11	15	12	9	150	30	11	8	2.7				€35
ET-S16Q-STWCR/L11	19	16	11	180	35	15	6	2.7		€35		
ET-S20Q-STWCR/L11	23	20	13	180	35	18	4	2.7		€35		
ET-S20Q-STWCR/L16	25	20	14.5	180	40	19	8	4		TC..16T3..		M3.5X9
ET-S25R-STWCR/L16	29	25	17	200	35	24	6	4	€35			
ET-S32S-STWCR/L16	39	32	22	250	40	30	4	5.5	€35			
ET-S40T-STWCR/L16	50	40	27	320	50	38	2	6.5	€65			
ET-S50U-STWCR/L16	60	50	31	350	60	48	0	5.5	€180			

93° SVJBR/L

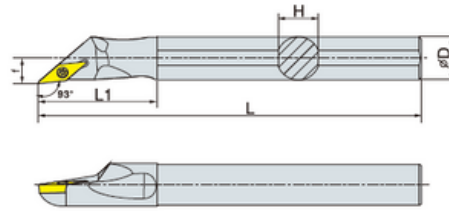
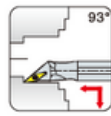

Cikkszám	Méret (mm)							Lapka	Csavar	Csavarkulcs	Ár
	Dmin	D	f	L	L1	H	K				
ET-S10K-SVJBR/L11	11	10	6	125	28	9	13	VB.1103..	M2.5X6	T-8	€35
ET-S12M-SVJBR/L11	13	12	7	150	35	11	10				€35
ET-S16Q-SVJBR/L11	17	16	9.5	180	40	15	10				€35
ET-S20Q-SVJBR/L11	21	20	11.5	180	45	18	8				M2.5X8
ET-S16Q-SVJBR/L16	19	16	11.5	180	48	15	11	VB.1604..	M3.5X9	T-15	€35
ET-S20Q-SVJBR/L16	21	20	11.5	180	52	18	11				€35
ET-S25R-SVJBR/L16	26	25	14	200	54	23	7				€35

93° SVCBR/L

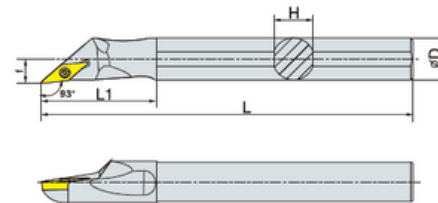
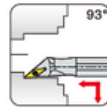

Cikkszám	Méret (mm)							Lapka	Csavar	Csavarkulcs	Ár
	Dmin	D	f	L	L1	H	K				
ET-S10K-SVCBR/L11	11	10	6	125	28	9	13	VC.1103..	M2.5X6	T-8	€35
ET-S12M-SVCBR/L11	13	12	7	150	35	11	10				€35
ET-S16Q-SVCBR/L11	17	16	9.5	180	40	15	10				€35
ET-S20Q-SVCBR/L11	21	20	11.5	180	45	18	8				M2.5X8
ET-S16Q-SVCBR/L16	19	16	11.5	180	48	15	11	VC.1604..	M3.5X9	T-15	€35
ET-S20Q-SVCBR/L16	21	20	11.5	180	52	18	11				€35
ET-S25R-SVCBR/L16	26	25	14	200	54	23	7				€35

117.5° SVQBR/L

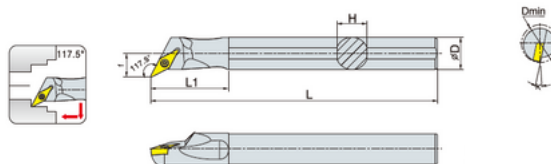

Cikkszám	Méret (mm)							Lapka	Csavar	Csavarkulcs	Ár
	Dmin	D	f	L	L1	H	K				
ET-S12M-SVQBR/L11	16	12	10	150	30	11	10	VB.1103..	M2.5X6	T-8	€35
ET-S16Q-SVQBR/L11	19	16	11.5	180	34	15	10		M2.5X8		€35
ET-S20Q-SVQBR/L11	24	20	14	180	45	18	8		€35		
ET-S20Q-SVQBR/L16	24	20	14	180	50	18	8	VB.1604.	M3.5X9	T-15	€35
ET-S25R-SVQBR/L16	29	25	17	200	50	23	6				€35
ET-S32S-SVQBR/L16	38	32	22.5	250	55	30	8				€35
ET-S40T-SVQBR/L16	47	40	27	300	55	38	6				€65
ET-S50U-SVQBR/L16	57	50	32	350	65	48	4				€180

117.5° SVQCR/L

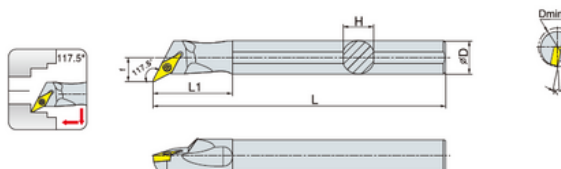

Cikkszám	Méret (mm)							Lapka	Csavar	Csavarkulcs	Ár
	Dmin	D	f	L	L1	H	K				
ET-S12M-SVQCR/L11	16	12	10	150	30	11	10	VC.1103..	M2.5X6	T-8	€35
ET-S16Q-SVQCR/L11	22	19	11.5	180	35	15	10		M2.5X8		€35
ET-S20Q-SVQCR/L11	27	24	14	180	34	18	8		€35		
ET-S20Q-SVQCR/L16	27	24	14	180	45	18	8	VC.1604..	M3.5X9	T-15	€35
ET-S25R-SVQCR/L16	32	29	17	200	50	23	6				€35
ET-S32S-SVQCR/L16	41	38	22.5	250	55	30	8				€35
ET-S40T-SVQCR/L16	50	47	27	300	55	38	6				€65
ET-S50U-SVQCR/L16	61	60	32	350	65	48	4				€220

96° SVXBR/L

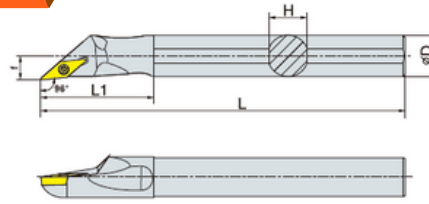
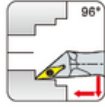

Cikkszám	Méret (mm)							Lapka	Csavar	Csavarkulcs	Ár
	Dmin	D	f	L	L1	H	K				
ET-S16Q-SVXBR/L11	19	16	11	180	40	15	10	VB.1103..	M2.5X8	T-8	€35
ET-S20Q-SVXBR/L11	23	20	13	180	45	18	8				€35
ET-S20Q-SVXBR/L16	23	20	13	180	45	18	8	VB.1604..	M3.5X9	T-15	€35
ET-S25R-SVXBR/L16	30	25	17	200	50	23	6				€35
ET-S32S-SVXBR/L16	38	32	22	250	60	30	8				€35
ET-S40T-SVXBR/L16	47	40	27	300	65	38	6				€65
ET-S50U-SVXBR/L16	60	50	31	350	70	48	4				€180

96° SVXCR/L

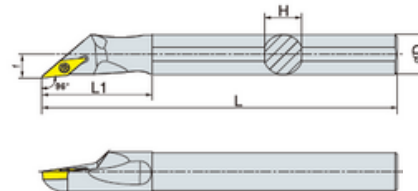

Cikkszám	Méret (mm)							Lapka	Csavar	Csavarkulcs	Ár
	Dmin	D	f	L	L1	H	K				
ET-S16Q-SVXCR/L11	19	16	11	180	40	15	10	VC.1103..	M2.5X8	T-8	€35
ET-S20Q-SVXCR/L11	23	20	13	180	45	18	8				€35
ET-S20Q-SVXCR/L16	23	20	13	180	45	18	8	VC.1604..	M3.5X9	T-15	€35
ET-S25R-SVXCR/L16	30	25	17	200	50	23	6				€35
ET-S32S-SVXCR/L16	38	32	22	250	60	30	8				€35
ET-S40T-SVXCR/L16	47	40	27	300	65	38	6				€65
ET-S50U-SVXCR/L16	60	50	31	350	70	48	4				€180

95° SVUBR/L

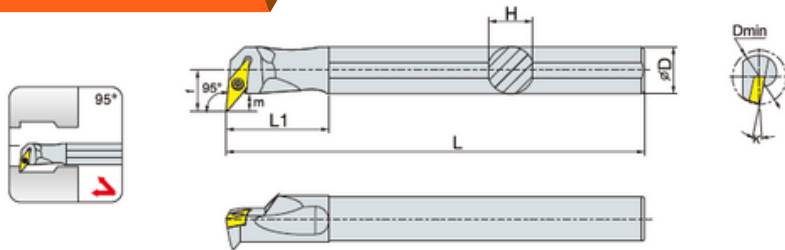

Cikkszám	Méret (mm)								Lapka	Csavar	Csavarkulcs	Ár
	Dmin	D	f	L	L1	H	K	m				
ET-S16Q-SVUBR/L11	20	16	11.5	180	30	15	10	3.2	VB.1103..	M2.5X8	T-8	€35
ET-S20Q-SVUBR/L11	24	20	14	180	30	18	8	3.7				€35
ET-S20Q-SVUBR/L16	29	20	19	200	45	18	8	8.5	VB.1604..	M3.5X9	T-15	€35
ET-S25R-SVUBR/L16	32	25	20	200	50	23	6	7				€35
ET-S32S-SVUBR/L16	38	32	22	250	50	30	6	5.5				€35
ET-S40T-SVUBR/L16	47	40	27	300	55	38	4	6.5				€65

95° SVUCR/L

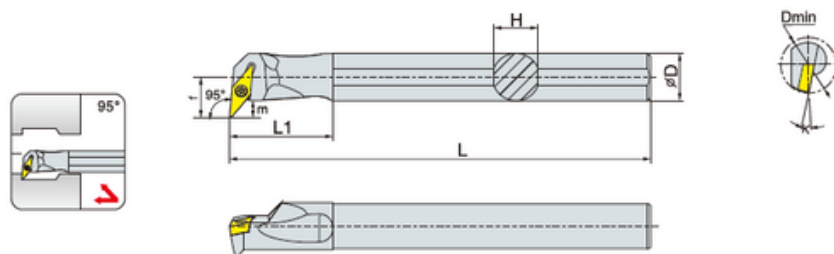

Cikkszám	Méret (mm)								Lapka	Csavar	Csavarkulcs	Ár
	Dmin	D	f	L	L1	H	K	m				
ET-S16Q-SVUCR/L11	20	16	11.5	180	30	15	10	3.2	VC.1103..	M2.5X8	T-8	€35
ET-S20Q-SVUCR/L11	24	20	14	180	30	18	8	3.7				€35
ET-S20Q-SVUCR/L16	29	20	19	200	45	18	8	8.5	VC.1604..	M3.5X9	T-15	€35
ET-S25R-SVUCR/L16	32	25	20	200	50	23	6	7				€35
ET-S32S-SVUCR/L16	38	32	22	250	50	30	6	5.5				€35
ET-S40T-SVUCR/L16	47	40	27	300	55	38	4	6.5				€65

72.5° SVWBR/L (belső hűtés)

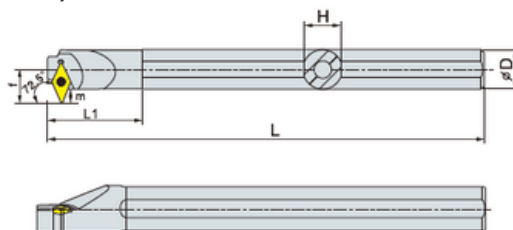
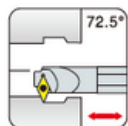

Cikkszám	Méret (mm)								Lapka	Csavar	Csavarkulcs	Ár
	Dmin	D	f	L	L1	H	m	K				
ET-S20Q-SVWBR/L11	24	20	14	180	35	18	3.7	8	VB.1103..	M2.5X8	T-8	€35
ET-S25R-SVWBR/L16	35	25	23	200	40	23	10	5	VB.1604.	M3.5X9	T-15	€35
ET-S32S-SVWBR/L16	42	32	26	250	45	30	9.5	5				€35

72.5° SVWCR/L (belső hűtés)

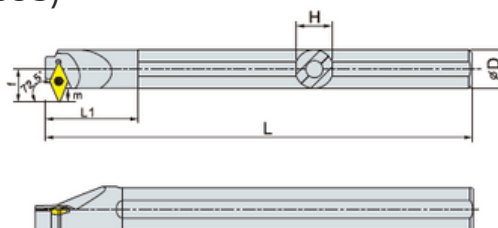
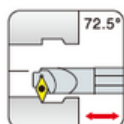

Cikkszám	Méret (mm)								Lapka	Csavar	Csavarkulcs	Ár
	Dmin	D	f	L	L1	H	m	K				
ET-S20Q-SVWCR/L11	24	20	14	180	35	18	3.7	8	VC.1103..	M2.5X8	T-8	€35
ET-S25R-SVWCR/L16	35	25	23	200	40	23	10	5	VC.1604..	M3.5X9	T-15	€35
ET-S32S-SVWCR/L16	42	32	26	250	45	30	9.5	5				€35

93° SVZBR/L

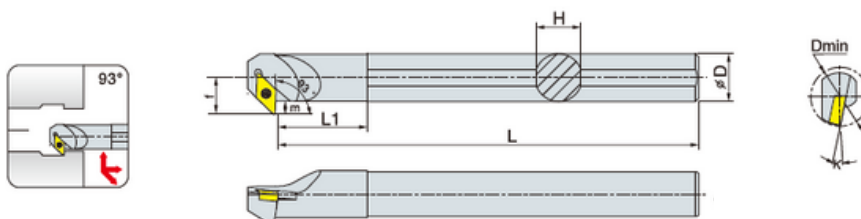

Cikkszám	Méret (mm)								Lapka	Csavar	Csavarkulcs	Ár
	Dmin	D	f	L	L1	H	K	m				
ET-S16Q-SVZBR/L11	19	16	11.5	180	30	15	10	3.2	VB..1103..	M2.5X8	T-8	€35
ET-S20Q-SVZBR/L11	24	20	14	180	35	18	8	3.7				€35
ET-S25R-SVZBR/L16	33	25	19.5	200	50	23	6	6.5	VB..1604..	M3.5X9	T-15	€35
ET-S32S-SVZBR/L16	39	32	23.5	250	50	30	8	7				€35
ET-S40T-SVZBR/L16	47	40	27	300	60	38	6	6.5				€65

93° SVZCR/L

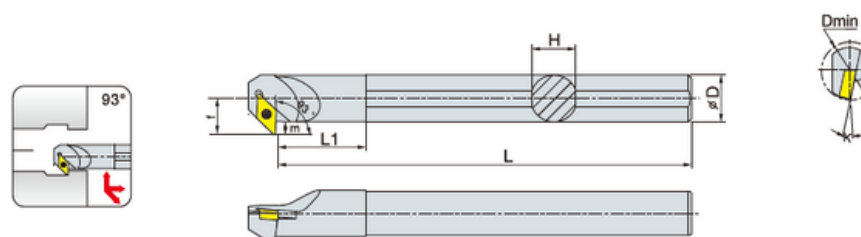

Cikkszám	Méret (mm)								Lapka	Csavar	Csavarkulcs	Ár
	Dmin	D	f	L	L1	H	K	m				
ET-S16Q-SVZCR/L11	19	16	11.5	180	30	15	10	3.2	VC..1103..	M2.5X8	T-8	€35
ET-S20Q-SVZCR/L11	24	20	14	180	35	18	8	3.7				€35
ET-S25R-SVZCR/L16	33	25	19.5	200	50	23	6	6.5	VC..1604..	M3.5X9	T-15	€35
ET-S32S-SVZCR/L16	39	32	23.5	250	50	30	8	7				€35
ET-S40T-SVZCR/L16	47	40	27	300	60	38	6	6.5				€65

95° SWLCR/L

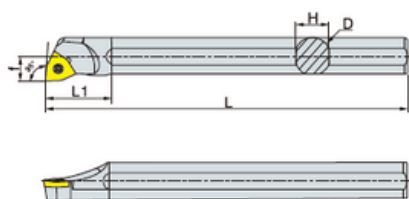
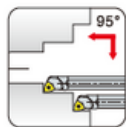

Cikkszám	Méret (mm)							Lapka	Csavar	Csavarkulcs	Ár
	Dmin	D	f	L	L1	H	K				
ET-S12M-SWLCR/L06	14	12	8.5	150	37	11	13	WC.06T3.	M3.5X9	T-15	€35
ET-S16Q-SWLCR/L06	19	16	11	180	40	15	10				€35
ET-S20Q-SWLCR/L06	23	20	13	180	40	18	8				€35
ET-S25R-SWLCR/L06	31	25	17	200	40	23	6				€35

95° SCLCR/L (belső hűtés)

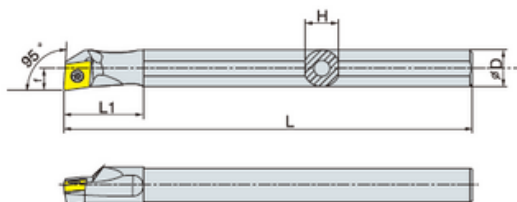
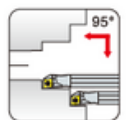

Cikkszám	Méret (mm)							Lapka	Csavar	Csavarkulcs	Ár
	Dmin	D	f	L	L1	H	K				
ET-C07K-SCLCR/L06	8	8	5	125	18	7	15	CC.0602..	M2.5X5	T-8	€35
ET-C08K-SCLCR/L06	9	8	5.5	125	18	7	13				€35
ET-C10M-SCLCR/L06	11	10	7	125	22	9	12		M2.5X6		€35
ET-C12Q-SCLCR/L06	13	12	8	150	25	11	10				€35
ET-C12Q-SCLCR/L09	16	14	5.5	150	27	13	10	CC.09T3..	M3.5X9	T-15	€35
ET-C16R-SCLCR/L09	17	16	11	180	34	15	10				€35
ET-C20S-SCLCR/L09	21	20	13	180	38	18	8				€35
ET-C25T-SCLCR/L09	26	25	17	200	45	23	6				€35

107.5° SDQCR/L

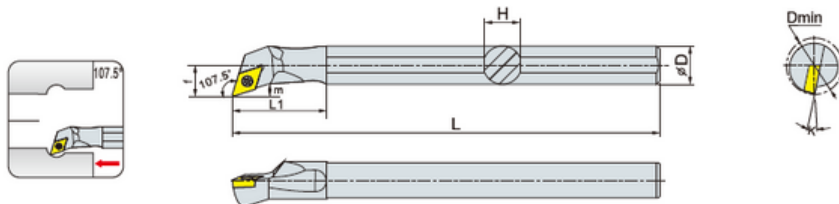

Cikkszám	Méret (mm)								Lapka	Csavar	Csavarkulcs	Ár
	Dmin	D	f	L	L1	H	m	K				
ET-C08K-SDQCR/L07	10	7	6	125	18	7	1.7	12	DC..0702..	M2.5X5	T-8	€35
ET-C10M-SDQCR/L07	11	10	7	125	24	9	1.7	10				€35
ET-C12Q-SDQCR/L07	15	12	9	150	30	11	2.7	8		M2.5X6		€35
ET-C16R-SDQCR/L07	17	16	11	180	30	15	2.7	6				€35
ET-C20S-SDQCR/L11	23	20	13	180	42	18	2.7	5	DC..11T3..	M3.5X9	T-15	€35
ET-C25T-SDQCR/L11	29	25	17	200	42.5	23	4	4				€35

95° SDUCR/L

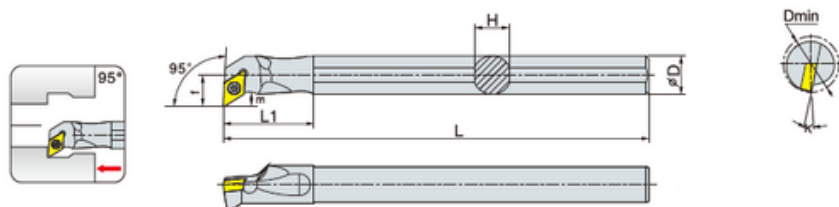

Cikkszám	Méret (mm)								Lapka	Csavar	Csavarkulcs	Ár
	Dmin	D	f	L	L1	H	m	K				
ET-C10M-SDUCR/L07	15	10	8	125	25	9	2.7	10	DC..0702..	M2.5X5	T-8	€35
ET-C12Q-SDUCR/L07	17	12	9	150	25	11	2.7	8				M2.5X6
ET-C16R-SDUCR/L07	22	16	11	180	30	15	2.7	6		€35		
ET-C16R-SDUCR/L11	19	16	11	180	34	15	2.7	8	DC..11T3..	M3.5X9	T-15	€35
ET-C20S-SDUCR/L11	23	20	13	180	40	18	2.7	6				€35
ET-C25T-SDUCR/L11	29	25	17	200	42	23	4	5				€35

91° STFPR/L (belső hűtés)

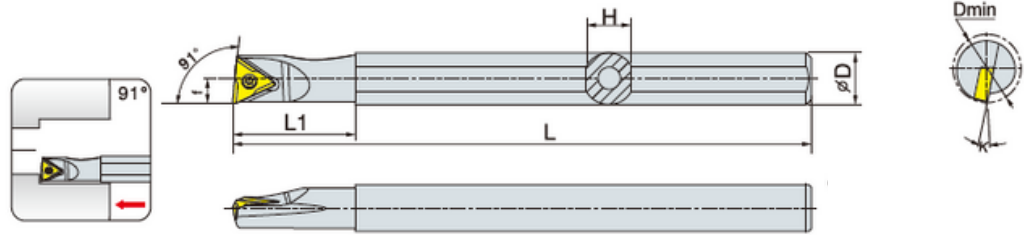

Cikkszám	Méret (mm)							Lapka	Csavar	Csavarkulcs	Ár
	Dmin	D	f	L	L1	H	K				
ET-C08K-STFPR/L09	9	8	5.5	125	20	7	15	TP.0902..	M2.5X6	T-6	€35
ET-C10M-STFPR/L09	11	10	6	125	24	9	13				€35
ET-C12Q-STFPR/L09	13	12	7	150	27	11	10				€35
ET-C10M-STFPR/L11	11	10	6	125	24	9	12	TP.1102..	M3.5X6	T-8	€35
ET-C12Q-STFPR/L11	13	12	7	150	26	11	10				€35
ET-C16R-STFPR/L11	17	16	9	180	32	15	8				€35
ET-C20S-STFPR/L11	21	20	11	180	40	18	6				€35

91° STFCR/L (belső hűtés)

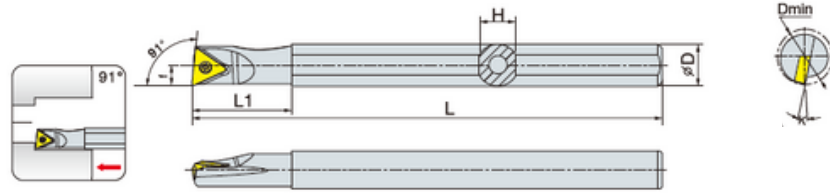

Cikkszám	Méret (mm)							Lapka	Csavar	Csavarkulcs	Ár	
	Dmin	D	f	L	L1	H	K					
ET-C08K-STFCR/L09	9	8	5.5	125	20	7	15	TC..0902..	M2.5X5	T-6	€35	
ET-C10M-STFCR/L09	11	10	6	125	24	9	13				€35	
ET-C12Q-STFCR/L09	13	12	7	150	27	11	10				€35	
ET-C10M-STFCR/L11	11	10	6	125	24	9	12	TC..1102..	M2.5X6	T-8	€35	
ET-C12Q-STFCR/L11	13	12	7	150	26	11	10				€35	
ET-C16R-STFCR/L11	17	16	9	180	32	15	8				M2.5X8	€35
ET-C20S-STFCR/L11	21	20	11	180	40	18	6					€35
ET-C20S-STFCR/L16	22	20	11.5	180	42	18	8	TC..16T3..	M3.5X9	T-15	€35	
ET-C25T-STFCR/L16	26	25	14	200	42	23	6				€35	

95° STUPR/L (belső hűtés)

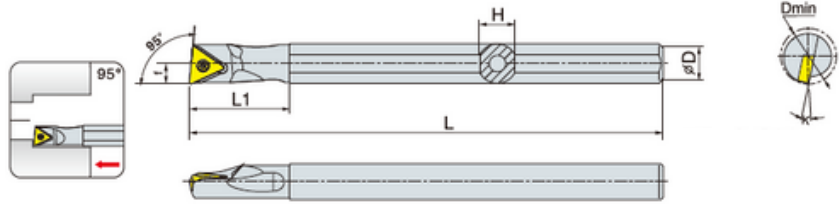

Cikkszám	Méret (mm)							Lapka	Csavar	Csavarkulcs	Ár
	Dmin	D	f	L	L1	H	K				
ET-C08K-STUPR/L09	9	8	5.5	125	20	7	15	TP.0902..	M2.5X6	T-6	€35
ET-C10M-STUPR/L09	11	10	6	125	24	9	13				€35
ET-C12Q-STUPR/L09	13	12	7	150	27	11	10				€35
ET-C10M-STUPR/L11	11	10	6	125	24	9	12	TP.1102..	M3X6	T-8	€35
ET-C12Q-STUPR/L11	13	12	7	150	26	11	10				€35
ET-C16R-STUPR/L11	17	16	9	180	32	15	8		M3X8		€35
ET-C20S-STUPR/L11	21	20	11	180	40	18	6				€35

95° STUCR/L

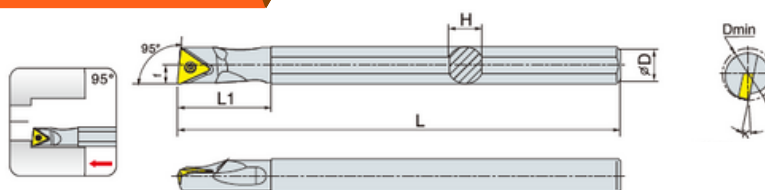

Cikkszám	Méret (mm)							Lapka	Csavar	Csavarkulcs	Ár
	Dmin	D	f	L	L1	H	K				
ET-C08K-STUCR/L09	9	8	5.5	125	20	7	15	TC..0902..	M2.5X5	T-6	€35
ET-C10M-STUCR/L09	11	10	6	125	24	9	13				€35
ET-C12Q-STUCR/L09	13	12	7	150	27	11	10				€35
ET-C10M-STUCR/L11	11	10	6	125	24	9	12	TC..1102..	M2.5X6	T-8	€35
ET-C12Q-STUCR/L11	13	12	7	150	27	11	10				€35
ET-C16R-STUCR/L11	17	16	9	180	32	15	8				€35
ET-C20S-STUCR/L11	21	20	11	180	37	18	6				€35
ET-C20S-STUCR/L16	23	20	13	180	42	18	7	TC..16T3..	M3.5X9	T-15	€35
ET-C25T-STUCR/L16	26	25	14	200	45	23	6				€35

91° STFB

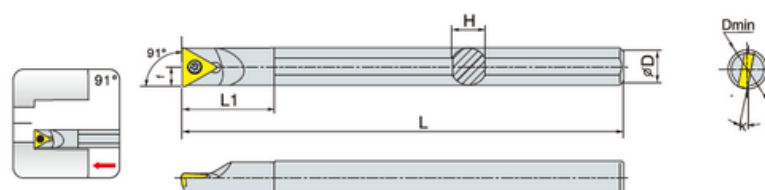

Cikkszám	Méret (mm)							Lapka	Csavar	Csavarkulcs	Ár
	Dmin	D	f	L	L1	H					
ET-S06G-STFBR06-06	7	6	3.6	90	3.6	5.2	TBCT060102	M2X4	T-6	€35	
ET-S06J-STFBR06-A08	7	8	3.6	110	3.6	7				€35	
ET-S06J-STFBR06-A10	7	10	3.6	110	3.6	9				€35	
ET-S06J-STFBR06-A12	7	12	3.6	110	3.6	10				€35	

93° SWUB

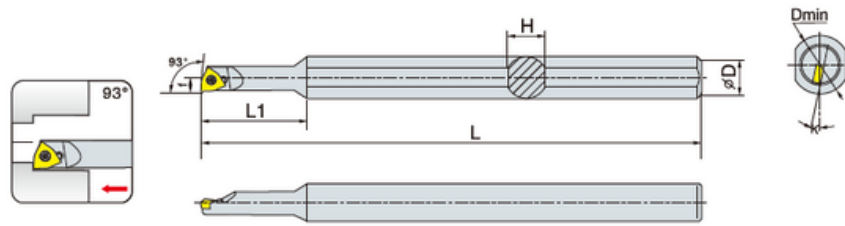

Cikkszám	Méret (mm)						Lapka	Csavar	Csavarkulcs	Ár
	Dmin	D	f	L	L1	H				
ET-S05H-SWUBR02-A10	6	10	3	100	19	9	WBGT020102	M2X4	T-6	€35

SVNR

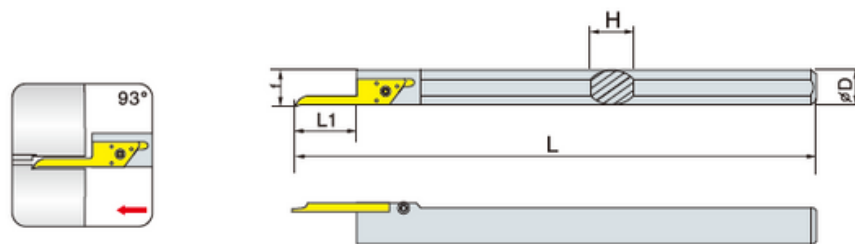

Cikkszám	Méret (mm)						Lapka	Csavar	Csavarkulcs	Ár
	Dmin	D	f	L	L1	H				
ET-SVNR1212K-12N	4	12	12.6	142	17	12	VNBR0411-02	M3X8 M3X4NC	T8 L1.5	€35



03. MENETKÉSEK

SER/L

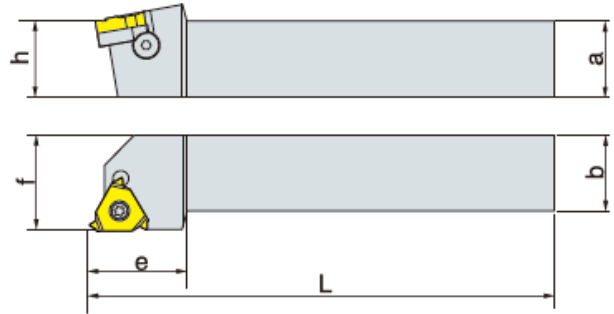
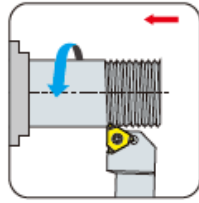

Cikkszám	Méret (mm)						Lapka	Alátét	Alátétlapka csavar	Lapkacsavar	Csavarkulcs	Ár
	b	a	L	e	h	f						
ET-SER/L-1212F11	12	12	80	20.5	12	16	11ER/L..	X	X	M2.5X8	T-8	€25
ET-SER/L-1212F16	12	12	80	22	12	16	16ER/L..	STM16(R) STM16(L)	M3X6N	M3.5X9	T-15	€25
ET-SER/L-1616H16	16	16	100	20.5	16	20				€25		
ET-SER/L-2020K16	20	20	125	30	20	25				€25		
ET-SER/L-2525M16	25	25	150	30	25	32				€25		
ET-SER/L-3232P16	32	32	170	30	32	40				€35		
ET-SER/L-2525M22	25	25	150	36	25	32				22ER/L..	STM22(R) STM22(L)	M4X6N
ET-SER/L-3232P22	32	32	170	36	32	40	€35					
ET-SER/L-4040R22	40	40	200	36	40	40	€35					
ET-SER/L-3232P27	32	32	170	40	32	40	27ER/L..	STM27(R) STM27(L)	M5X8N	M5X20	T-20	€35
ET-SER/L-4040R27	40	40	200	40	40	50						€35

B-SER/L

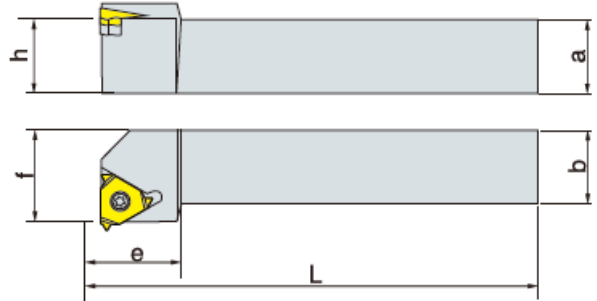
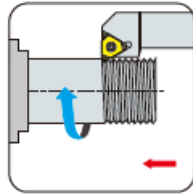

Cikkszám	Méret (mm)						Lapka	Alátét	Alátétlapka csavar	Lapkacsavar	Csavarkulcs	Ár
	b	a	L	e	h	f						
ET-B-SER/L-1212H16	12	12	100	17.8	12	17.2	16ER/L	X	X	M3.5X9	T-15	€25
ET-B-SER/L-1414H16	14	14	100	17.8	14	17.2						€25
ET-B-SER/L-1616H16	16	16	100	23	16	20		STM16(R) STM16(L)	M3X6N	M3.5X12	T-15	€25
ET-B-SER/L-2020K16	20	20	125	23	20	20						€25

SER/L-V

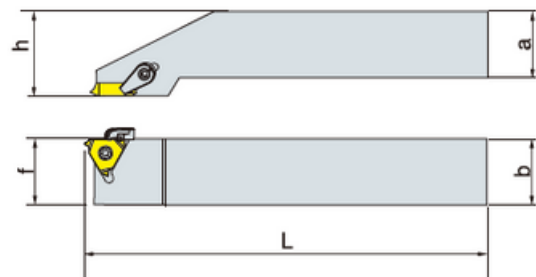
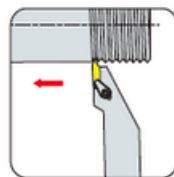

Cikkszám	Méret (mm)					Lapka	Szorító	Szorító csavar	Lapkacsavar	Csavarkulcs	Ár
	b	a	L	h	f						
ET-SER/L-V-1616H16	16	16	100	16	16	16VER/L	CS6R1	ML0622	M3.5X9	T-15	€25
ET-SER/L-V-2020K16	20	20	125	20	20						€25
ET-SER/L-V-2525M16	25	25	150	25	25						€25

SER-U

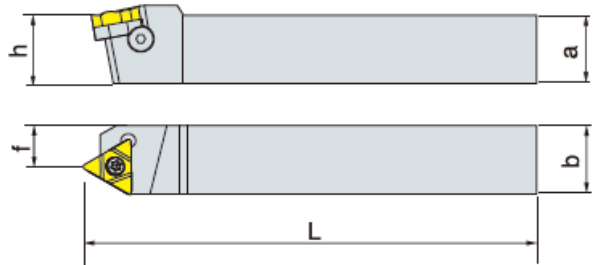
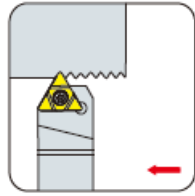

Cikkszám	Méret (mm)					Lapka	Alátét	Alátétlapka csavar	Lapkacsavar	Csavarkulcs	Ár
	b	a	L	h	f						
ET-SER-U-2525M22	25	25	150	25	14	4UE..	YE4U	M4X6N	M4X16	T20	€25
ET-SER-U-3232P22	32	32	170	32	21.5						€35

SNR/L

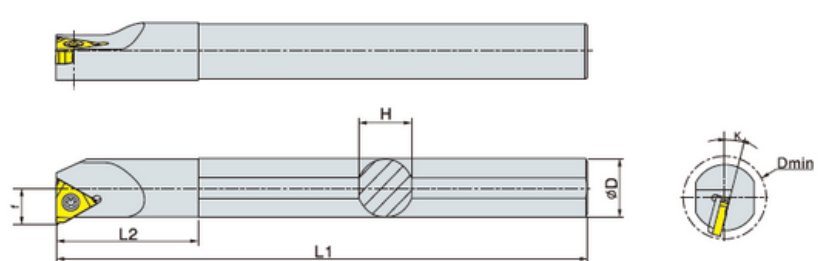
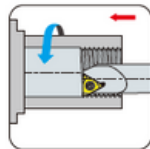

Cikkszám	Méret (mm)						Lapka	Alátét	Alátétlapka csavar	Lapkacsavar	Csavarkulcs	Ár
	Dmin	D	f	L1	L2	H						
ET-SNR/L0008K08	9.9	08	5.5	125	20	7	08NR/L..		M2.2X5	T-6	€35	
ET-SNR/L0010K11	13	10	7.3	125	25	9	11NR/L..	X	M2.5X8	T-8	€35	
ET-SNR/L0010K11-A16	13	16	7.3	125	30	15					€35	
ET-SNR/L0012K11	15	12	8.4	125	28	11					€35	
ET-SNR/L0012K11-A16	15	16	8.4	125	36	15					€35	

SNR/L

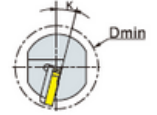
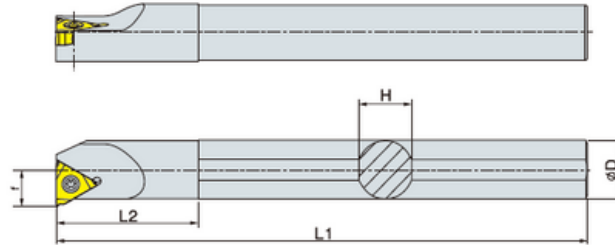
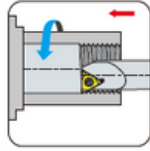

Cikkszám	Méret (mm)						Lapka	Alátét	Alátétlapka csavar	Lapkacsavar	Csavarkulcs	Ár
	Dmin	D	f	L1	L2	H						
ET-SNR/L0013M16	17	16	10.3	150	32	15	16NR/L.	STM16(R) STM16(L)	M3X6N	M3.5X12	T-15	€35
ET-SNR/L0016Q16	20	16	11.5	180	40	15						€35
ET-SNR/L0020Q16	24	20	13.4	180	40	18						€35
ET-SNR/L0025R16	29	25	16.3	200	45	23						€35
ET-SNR/L0032S16	36	32	19.6	250	50	30						€35
ET-SNR/L0040T16	44	40	23.8	300	55	38						€65
ET-SNR/L0050U16	56	50	28.7	350	60	48						€180
ET-SNR/L0020Q22	27	20	14.9	180	40	18	22NR/L.	X	X	M4X12-S22	T-20	€35
ET-SNR/L0025R22	32	25	18.1	200	45	23		€35				
ET-SNR/L0032S22	39	32	21.5	250	50	30		STM22(R) STM22(L)	M4X6N	M4X16		€35
ET-SNR/L0040T22	47	40	25.8	300	55	38		€65				
ET-SNR/L0050U22	57	50	20.6	350	70	48		€180				
ET-SNR/L0032S27	40	32	22.4	250	60	30	27NR/L.	STM27(R) STM27(L)	M5X6N	M5X20	T-20	€35
ET-SNR/L0050T27	48	50	26.4	300	60	36						€180
ET-SNR/L0060U27	58	60	31.4	350	75	45						€220

SIR/L

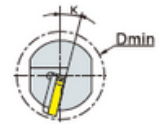
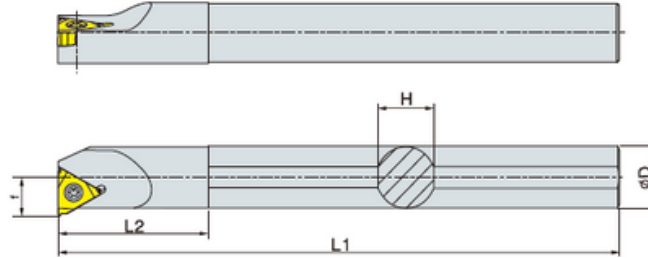
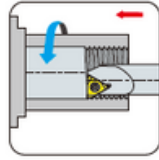

Cikkszám	Méret (mm)						Lapka	Alátét	Alátétlapka csavar	Lapkacsavar	Csavarkulcs	Ár
	Dmin	D	f	L1	L2	H						
ET-SIR/L0008K08	9.9	08	5.0	125	21	7						€35
ET-SIR/L0008A10	9.9	10	5.0	125	24	9	08NR/L..	X	X	M2.2X5	T-6	€35
ET-SIR/L0008A16	9.9	16	5.0	125	24	15						€35



04. BESZÚRÓ,- LESZÚRÓ,- ÉS KÜLÖNLEGES KÉSEK

MGEHR/L

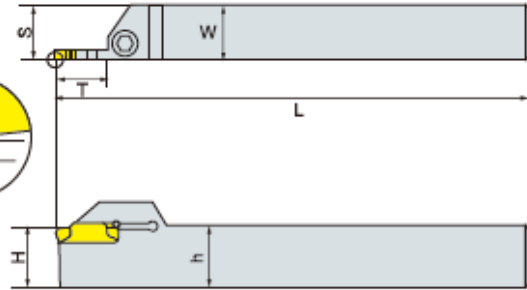
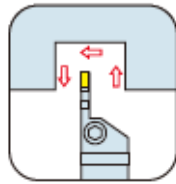

Cikkszám	Méret (mm)					Lapka	Szorító csavar	Csavarkulcs	Ár
	W	H=h	L	S	T-MAX				
ET-MGEHR/L1616-1.5	16	16	100	16.25	14.5	MGMN150-G	M5X12N	L4.0	€25
ET-MGEHR/L2020-1.5	20	20	125	20.25	14.5				€25
ET-MGEHR/L1616-2	16	16	100	16.25	14.5	MGMN200-G MGMN200-M	M5X16N	L4.0	€25
ET-MGEHR/L2020-2	20	20	125	20.25	14.5				€25
ET-MGEHR/L2525-2	25	25	150	25.25	14.5				€25
ET-MGEHR/L1616-2.5	16	16	100	16.30	16.5	MGMN250-G MGMN250-M	M5X16N	L4.0	€25
ET-MGEHR/L2020-2.5	20	20	125	20.30	16.5				€25
ET-MGEHR/L2525-2.5	25	25	150	25.30	16.5				€25
ET-MGEHR/L1616-3	16	16	100	16.35	18.5	MGMN300-M MGMN300...-M MRMN300-M	M6X20N	L5.0	€25
ET-MGEHR/L2020-3	20	20	125	20.4	18				€25
ET-MGEHR/L2020-3-T10	20	20	125	20.4	10				€25
ET-MGEHR/L2525-3	25	25	150	25.4	18				€25
ET-MGEHR/L2525-3-T10	25	25	150	25.4	10				€25
ET-MGEHR/L3232-3	32	32	170	32.4	18				€35

MGEHR/L

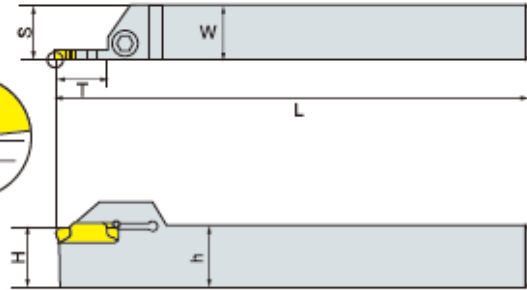
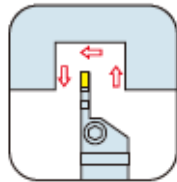

Cikkszám	Méret (mm)					Lapka	Szorító csavar	Csavarkulcs	Ár						
	W	H=h	L	S	T-MAX										
ET-MGEHR/L2020-4	20	20	125	20.4	18	MGMN400-M MCGN400-M MRMN400-M	M6X20N	L5.0	€25						
ET-MGEHR/L2020-4-T10	20	20	125	20.4	10				€25						
ET-MGEHR/L2525-4	25	25	150	25.4	18				€25						
ET-MGEHR/L2525-4-T10	25	25	150	25.4	10				€25						
ET-MGEHR/L3232-4	32	32	170	32.4	18	MGMN500-M MCGN500-M MRMN500-M			M6X20N	L5.0	€35				
ET-MGEHR/L2525-5	25	25	150	25.5	23						€25				
ET-MGEHR/L2525-5-T15	25	25	150	25.5	15						€25				
ET-MGEHR/L3232-5	32	32	170	32.5	23	MGMN600-M MCGN600-M MRMN600-M					M6X20N	L5.0	€35		
ET-MGEHR/L2020-6	20	20	125	20.6	23								€25		
ET-MGEHR/L2020-6-T15	20	20	125	20.6	15								€25		
ET-MGEHR/L2525-6	25	25	150	25.6	23	MGMN600-M MCGN600-M MRMN600-M							M6X20N	L5.0	€25
ET-MGEHR/L2525-6-T15	25	25	150	25.6	15										€25
ET-MGEHR/L3232-6	32	32	170	32.6	23		€35								

TTER/L

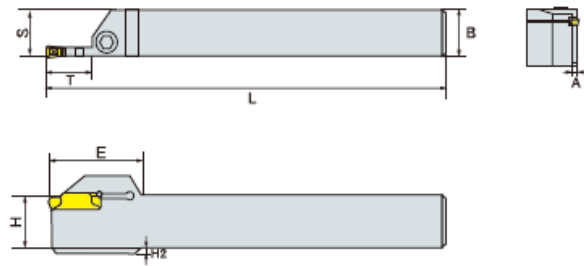
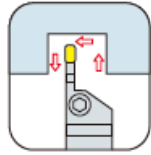

Cikkszám	Méret (mm)							Lapka	Szorító csavar	Csavarkulcs	Ár
	H=B	L	S	E	A	H2	T-MAX				
ET-TTER/L1616-2T08	16	110	15.1								€25
ET-TTER/L2020-2T08	20	125	19.1	33	1.8	4	8.0	TD..D2	M5X16N	L-W4	€25
ET-TTER/L2525-2T08	25	150	24.1								€25
ET-TTER/L1616-2	16	110	15.1								€25
ET-TTER/L2020-2	20	125	19.1	32			12.0				€25
ET-TTER/L2525-2	25	150	24.1								€25
ET-TTER/L1616-2T17	16	110	15.1		1.8	4		TD..D2	M5X16N	L-W4	€25
ET-TTER/L2020-2T17	20	125	19.1	37			17.0				€25
ET-TTER/L2525-2T17	25	150	24.1								€25
ET-TTER/L1616-3T09	16	110	14.8								€25
ET-TTER/L2020-3T09	20	125	18.8				9.0				€25
ET-TTER/L2525-3T09	25	150	23.8								€25
ET-TTER/L1616-3	16	110	14.8	32							€25
ET-TTER/L2020-3	20	125	18.8				12.0				€25
ET-TTER/L2525-3	25	150	23.8		2.4	4		TD..D3	M5X16N	L-W4	€25
ET-TTER/L1616-3T20	16	110	14.8								€25
ET-TTER/L2020-3T20	20	125	18.8	38.5			20.0				€25
ET-TTER/L2525-3T20	25	150	23.8								€25
ET-TTER/L2525-3T25	25	150	23.8	44.5			25.0				€25

TTER/L

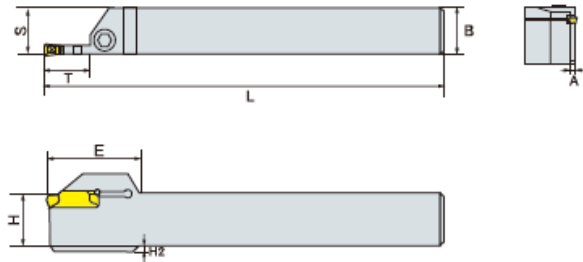
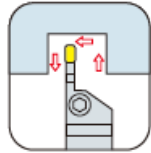

Cikkszám	Méret (mm)							Lapka	Szorító csavar	Csavarkulcs	Ár								
	H=B	L	S	E	A	H2	T-MAX												
ET-TTER/L1616-4T10	16	110	14.8	32	3.0	4	10.0	TD..D4	M6X16N	L-W5	€25								
ET-TTER/L2020-4T10	20	125	18.8								€25								
ET-TTER/L2525-4T10	25	150	23.8								€25								
ET-TTER/L1616-4	16	110	14.8	33			4.0				4	15.0	M6X16N	L-W5	€25				
ET-TTER/L2020-4	20	125	18.8												€25				
ET-TTER/L2525-4	25	150	23.8												€25				
ET-TTER/L1616-4T25	16	110	14.8	45								4.0			4	25.0	M6X16N	L-W5	€25
ET-TTER/L2020-4T25	20	125	18.8																€25
ET-TTER/L2525-4T25	25	150	23.8																€25
ET-TTER/L2020-5T12	20	125	18.1	37	4.0	4		12.0	M6X16N	L-W5						€25			
ET-TTER/L2525-5T12	25	150	23.8													€25			
ET-TTER/L2020-5	20	125	18.1													20.0			€25
ET-TTER/L2525-5	25	150	23.8	€25															
ET-TTER/L2525-5T32	25	150	23.8	56			32.0	€25											

CGWSR/L

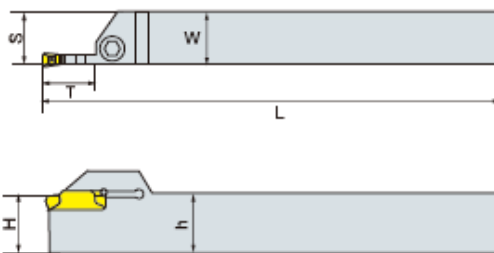
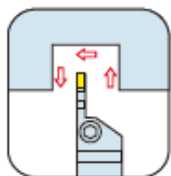

Cikkszám	Méret (mm)					Lapka	Szorító csavar	Csavarkulcs	Ár
	W	H=h	L	S	T-MAX				
ET-CGWSR/L1616-W2-L	16	16	100	16.2	16.5	WGE20 WGE20R/L	M5X20N	L4	€25
ET-CGWSR/L2020-W2-L	20	20	125	20.2	16.5				€25
ET-CGWSR/L2525-W2-L	25	25	150	25.2	16.5				€25
ET-CGWSR/L1616-W3	16	16	100	16.4	13.5	WGE30 WGT30 WGE30R/L WGR30			€25
ET-CGWSR/L2020-W3	20	20	125	20.4	13.5				€25
ET-CGWSR/L2525-W3	25	25	150	25.4	13.5				€25
ET-CGWSR/L1616-W3-L	16	16	100	16.4	20.5	WGE30 WGT30 WGE30R/L WGR30			€25
ET-CGWSR/L2020-W3-L	20	20	125	20.4	20.5				€25
ET-CGWSR/L2525-W3-L	25	25	150	25.4	20.5				€25
ET-CGWSR/L2020-W4	20	20	125	20.4	14.5	WGE40 WGT40 WGE40R/L WGR40	M6X20N	L5	€25
ET-CGWSR/L2525-W4	25	25	150	25.4	14.5				€25
ET-CGWSR/L2020-W4-L	20	20	125	20.4	25.5	WGE40 WGT40 WGE40R/L WGR40			€25
ET-CGWSR/L2525-W4-L	25	25	150	25.4	25.5				€25
ET-CGWSR/L2020-WS	20	20	125	20.4	14.5	WGE50 WGT50 WGE50R/L WGR50			€25
ET-CGWSR/L2525-WS	25	25	150	25.4	14.5				€25
ET-CGWSR/L2020-WS-L	20	20	125	20.4	25.5	WGE50 WGT50 WGE50R/L WGR50			€25
ET-CGWSR/L2020-WS-L	25	25	150	25.4	25.5				€25

SMBB

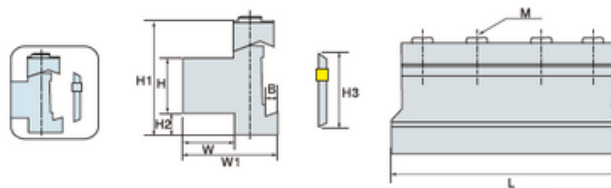

Cikkszám	Méret (mm)									Kés	Csavarkulcs	Ár
	H	W	H3	L	H1	H2	W1	B	M			
ET-SMBB1626	16	12	26	86	43	13	30	5.3	3-M6	SPB.26 SPB.32 SPB.26-S SPB.32-S	L5.0	€60
ET-SMBB2026	20	19	26	86	43	9	38	5.3	3-M6			€60
ET-SMBB2032	20	19	32	100	50	13	38	5.3	4-M6			€60
ET-SMBB2526	25	23	26	86	43	4	42	5.3	4-M6			€60
ET-SMBB2532	25	23	32	110	50	8	42	5.3	4-M6			€60
ET-SMBB3232	32	30	32	110	54	5	48	5.3	4-M6			€60

SPB

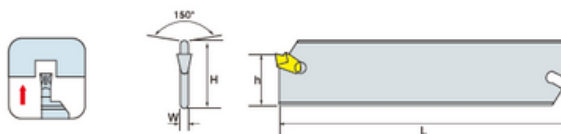

Cikkszám	Méret (mm)				Lapka	Csavarkulcs	Ár
	H	W	L	h			
ET-SPB226	26	1.6	110	21	SP200,200R/L	SW80-S	€25
ET-SPB326	26	2.4	110	21	SP300,300R/L		€25
ET-SPB426	26	3.2	110	21	SP400,400R/L		€25
ET-SPB526	26	4.0	110	21	SP500,500R/L		€25
ET-SPB626	26	5.2	110	21	SP600,600R/L		€25
ET-SPB232	32	1.6	150	25	SP200,200R/L		€25
ET-SPB332	32	2.4	150	25	SP300,300R/L		€25
ET-SPB432	32	3.2	150	25	SP400,400R/L		€25
ET-SPB532	32	4.0	150	25	SP500,500R/L		€25
ET-SPB632	32	5.2	150	25	SP600,600R/L		€25

SPB



Cikkszám	Méret (mm)				Lapka	Csavarkulcs	Ár
	H	W	L	h			
ET-SPB226-S	26	1.6	110	21	SP200,200R/L	SW80-S	€25
ET-SPB326-S	26	2.4	110	21	SP300,300R/L		€25
ET-SPB426-S	26	3.2	110	21	SP400,400R/L		€25
ET-SPB526-S	26	4.0	110	21	SP500,500R/L		€25
ET-SPB626-S	26	5.2	110	21	SP600,600R/L		€25
ET-SPB232-S	32	1.6	150	25	SP200,200R/L		€25
ET-SPB332-S	32	2.4	150	25	SP300,300R/L		€25
ET-SPB432-S	32	3.2	150	25	SP400,400R/L		€25
ET-SPB532-S	32	4.0	150	25	SP500,500R/L		€25
ET-SPB632-S	32	5.2	150	25	SP600,600R/L		€25

ZQ

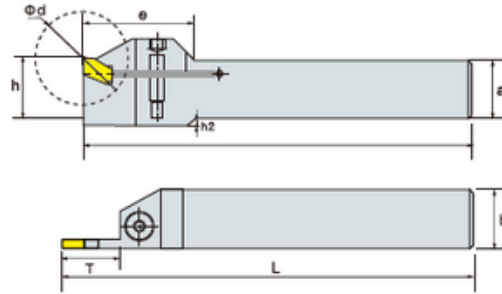
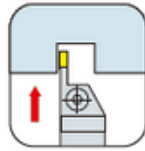

Cikkszám	Méret (mm)					Lapka	Szorító csavar	Csavarkulcs	Ár
	a	b	L	h	T				
ET-ZQ1616R/L-02	16	16	100	16.3	16	SP200.200R/L	M4X16N	L3.0	€25
ET-ZQ2020R/L-02	20	20	125	20.3	16				€25
ET-ZQ1616R/L-03	16	16	100	16.3	16	SP300.300R/L	M5X20N	L4.0	€25
ET-ZQ2020R/L-03	20	20	125	20.3	20				€25
ET-ZQ2020R/L-03-25	20	20	125	25.3	25				€25
ET-ZQ2525R/L-03	25	25	150	20.3	20				€25
ET-ZQ2525R/L-03-25	25	25	150	25.3	25				€25
ET-ZQ3232R/L-03	32	32	170	32.3	20				€35
ET-ZQ1616R/L-04	16	16	100	16.3	16	SP400.400R/L	M5X20N	L4.0	€25
ET-ZQ2020R/L-04	20	20	125	20.3	20				€25
ET-ZQ2020R/L-04-25	20	20	125	25.3	25				€25
ET-ZQ2525R/L-04	25	25	150	20.3	20				€25
ET-ZQ2525R/L-04-25	25	25	150	25.3	25				€25
ET-ZQ3232R/L-04	32	32	170	32.3	20				€35

ZQ

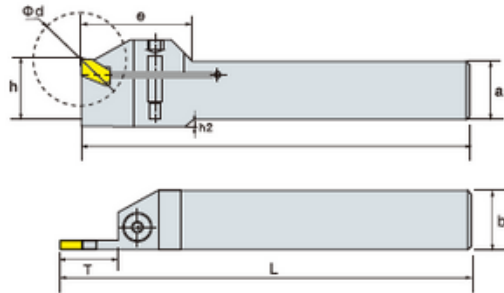
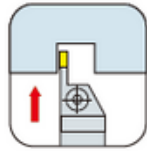

Cikkszám	Méret (mm)					Lapka	Szorító csavar	Csavarkulcs	Ár
	a	b	L	h	T				
ET-QZQ1616R/L-02	16	16	100	16.3	16	SP200,200R/L	M4X16N	L3.0	€25
ET-QZQ2020R/L-02	20	20	125	20.3	16				€25
ET-QZQ1616R/L-03	16	16	100	16.3	16	SP300,300R/L			€25
ET-QZQ2020R/L-03	20	20	125	20.3	20				€25
ET-QZQ2020R/L-03-25	20	20	125	25.3	25				€25
ET-QZQ2525R/L-03	25	25	150	20.3	20				€25
ET-QZQ2525R/L-03-25	25	25	150	25.3	25				€25
ET-QZQ3232R/L-03	32	32	170	32.3	20				€35
ET-QZQ1616R/L-04	16	16	100	16.3	16	SP400,400R/L	M5X20N	L4.0	€25
ET-QZQ2020R/L-04	20	20	125	20.3	20				€25
ET-QZQ2020R/L-04-25	20	20	125	25.3	25				€25
ET-QZQ2525R/L-04	25	25	150	20.3	20				€25
ET-QZQ2525R/L-04-25	25	25	150	25.3	25				€25
ET-QZQ3232R/L-04	32	32	170	32.3	20				€35

SPH

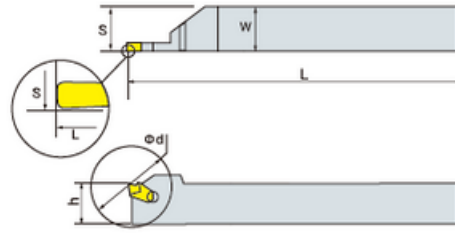
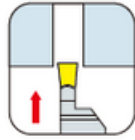

Cikkszám	Méret (mm)					Lapka	Csavarkulcs	Ár
	d	H=h	W	L	S			
ET-SPH316R/L	32	16	16	100	16.3	SP300, 300R/L SP400, 400R/L SP500, 500R/L	SW80-S	€35
ET-SPH320R/L	40	20	20	120	20.3			€35
ET-SPH420R/L	50	20	20	120	25.3			€35
ET-SPH520R/L	60	20	20	120	20.4			€35
ET-SPH325R/L	50	25	25	150	25.4	SP300, 300R/L SP400, 400R/L SP500, 500R/L	SW80-S	€35
ET-SPH425R/L	60	25	25	150	20.4			€35
ET-SPH525R/L	70	25	25	150	25.4			€35

Cikkszám	Méret (mm)					Lapka	Csavarkulcs	Ár
	d	H=h	W	L	S			
ET-SPH316R/L-S	32	16	16	100	16.3	SP300, 300R/L SP400, 400R/L SP500, 500R/L	SW80-S	€35
ET-SPH320R/L-S	40	20	20	120	20.3			€35
ET-SPH420R/L-S	50	20	20	120	25.3			€35
ET-SPH520R/L-S	60	20	20	120	20.4			€35
ET-SPH325R/L-S	50	25	25	150	25.4	SP300, 300R/L SP400, 400R/L SP500, 500R/L	SW80-S	€35
ET-SPH425R/L-S	60	25	25	150	20.4			€35
ET-SPH525R/L-S	70	25	25	150	25.4			€35

MGEUR/L

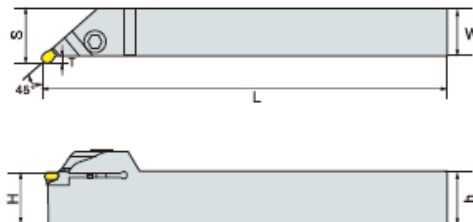
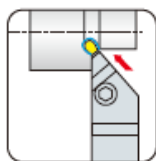

Cikkszám	Méret (mm)					Lapka	Szorító csavar	Csavarkulcs	Ár
	W	H=h	L	S	T-MAX				
ET-MGEUR/L2020-3	20	20	125	23	3	MRMN300-M MRMN400-M	M6X20N	L5	€25
ET-MGEUR/L2525-3	25	25	150	28	3				€25
ET-MGEUR/L3232-3	32	32	170	35	3				€35
ET-MGEUR/L2020-4	20	20	125	23	3				€25
ET-MGEUR/L2525-4	25	25	150	28	3				€25
ET-MGEUR/L3232-4	32	32	170	35	3				€35

JSTGR/L

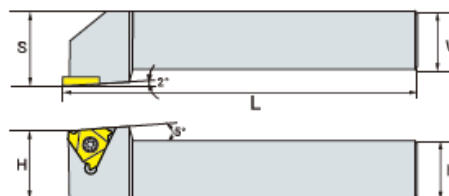
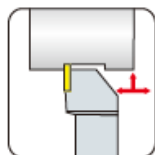

Cikkszám	Méret (mm)					Lapka	Szorító csavar	Csavarkulcs	Ár
	W	H	L	S	h				
ET-JSTGR/L1212-H16C	12	12	100	16	12	JSTGR/L3.. TGF32R/L	M3.5X9	T15	€25
ET-JSTGR/L1616-H16C	16	16	100	20	16				€25
ET-JSTGR/L2020-K16C	20	20	125	25	20				€25
ET-JSTGR/L2525-M16C	25	25	150	32	25				€25
ET-JSTGR/L2020-K22C	20	20	125	25	20	JSTGR/L4.. TGF43R/L	M5X12	T20	€25
ET-JSTGR/L2525-M22C	25	25	150	32	25				€25



SGBAR/L, SWTR/L

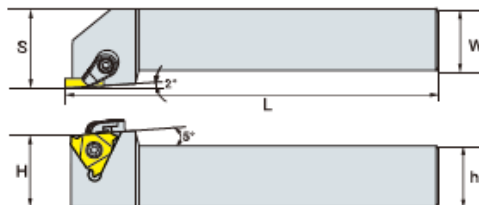
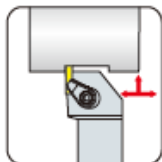

Cikkszám	Méret (mm)					Lapka	Szorító csavar	Szorító	Csavar	Csavarkulcs	Ár
	W	H	S	L	h						
ET-SGBAR/L1616-H16C	16	16	20	100	16	GBA32R/L	ML0622	CS6R1	M3.5X9	T15, L3.0	€25
ET-SGBAR/L2020-K16C	20	20	25	125	20						€25
ET-SGBAR/L2525-M16C	25	25	32	150	25						€25
ET-SGBAR/L2020-K22C	20	20	25	125	20	GBA43R/L	ML0622	CS6R1	M5X12	T20, L3.0	€25
ET-SGBAR/L2525-M22C	25	25	32	150	25						€25

Cikkszám	Méret (mm)					Lapka	Szorító csavar	Szorító	Csavar	Csavarkulcs	Ár
	W	H	S	L	h						
ET-SWTR/L1616-H16C	16	16	20	100	16	JTGR/L3	ML0622	CS6R1	M3.5X9	T15, L3.0	€25
ET-SWTR/L2020-K16C	20	20	25	125	20						€25
ET-SWTR/L2525-M16C	25	25	32	150	25						€25
ET-SWTR/L2020-K22C	20	20	25	125	20	WL325R/L	ML0622	CS6R1	M5X12	T20, L3.0	€25
ET-SWTR/L2525-M22C	25	25	32	150	25						€25

PCHR/L

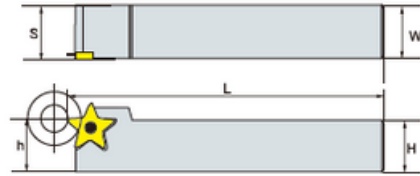
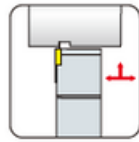

Cikkszám	Méret (mm)					Lapka	Csavar	Csavarkulcs	Ár
	W	H	L	S	h				
ET-PCHR/L16-16	16	16	100	16.6	16	PENTA 24N239J015	M5X12P	T20	€25
ET-PCHR/L16-20	20	20	125	20.6	20				€25
ET-PCHR/L16-25	25	25	150	25.5	25				€25

SFVCR



Cikkszám	Méret (mm)					Lapka	Csavar	Csavarkulcs	Ár
	W	H	L	S	h				
ET-SFVCR2020K16	20	20	125	25	20	VC1604..	M3.5X9	T15	€25
ET-SFVCR2525M16	25	25	150	32	25				€25

FGVH

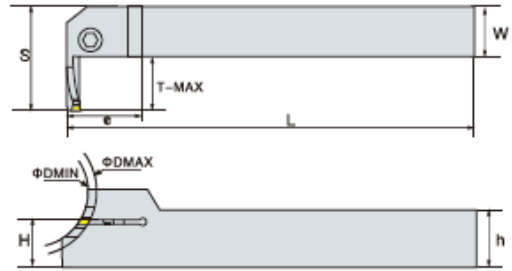
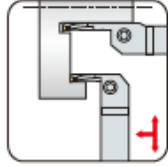

Cikkszám	Méret (mm)							Lapka	Szorító csavar	Csavarkulcs	Ár
	W	H=h	L	S	T-MAX	DMIN	DMAX				
ET-FGVH320R-25/30	20	20	125	20.6	13	25	30	FMM300R-03	M6X20N	L5	€25
ET-FGVH320R-30/35	20	20	125	20.6	13	30	35				€25
ET-FGVH320R-35/48	20	20	125	20.6	13	35	48				€25
ET-FGVH320R-48/60	20	20	125	20.6	22	48	60	FGD300R-03 FGM300R-03			€25
ET-FGVH320R-60/75	20	20	125	20.6	22	60	75				€25
ET-FGVH320R-75/100	20	20	125	20.6	22	75	100				€25
ET-FGVH320R-100/140	20	20	125	20.6	22	100	140				€25
ET-FGVH325R-25/30	25	25	150	25.6	13	25	30	FMM300R-03			€25
ET-FGVH325R-30/35	25	25	150	25.6	13	30	35				€25
ET-FGVH325R-35/48	25	25	150	25.6	13	35	48				€25
ET-FGVH325R-48/60	25	25	150	25.6	22	48	60	FGD300R-03 FGM300R-03			€25
ET-FGVH325R-60/75	25	25	150	25.6	22	60	75				€25
ET-FGVH325R-75/100	25	25	150	25.6	22	75	100		€25		
ET-FGVH325R-100/140	25	25	150	25.6	22	100	140		€25		

FGVH

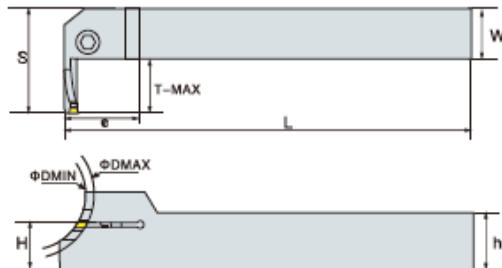
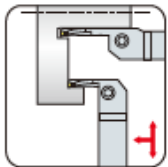

Cikkszám	Méret (mm)							Lapka	Szorító csavar	Csavarkulcs	Ár
	W	H=h	L	S	T-MAX	DMIN	DMAX				
ET-FGVH420R-25/30	20	20	125	20.6	13	25	30	FMM400R-04	M6X20N	L5	€25
ET-FGVH420R-30/35	20	20	125	20.6	13	30	35				€25
ET-FGVH420R-35/48	20	20	125	20.6	13	35	48				€25
ET-FGVH420R-48/60	20	20	125	20.6	22	48	60	FGD400R-04 FGM400R-04			€25
ET-FGVH420R-60/75	20	20	125	20.6	22	60	75				€25
ET-FGVH420R-75/100	20	20	125	20.6	22	75	100				€25
ET-FGVH420R-100/140	20	20	125	20.6	22	100	140				€25
ET-FGVH425R-25/30	25	25	150	25.6	13	25	30	FMM400R-04			€25
ET-FGVH425R-30/35	25	25	150	25.6	13	30	35				€25
ET-FGVH425R-35/48	25	25	150	25.6	13	35	48				€25
ET-FGVH425R-48/60	25	25	150	25.6	22	48	60	FGD400R-04 FGM400R-04			€25
ET-FGVH425R-60/75	25	25	150	25.6	22	60	75				€25
ET-FGVH425R-75/100	25	25	150	25.6	22	75	100		€25		
ET-FGVH425R-100/140	25	25	150	25.6	22	100	140		€25		



FGHH

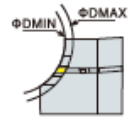
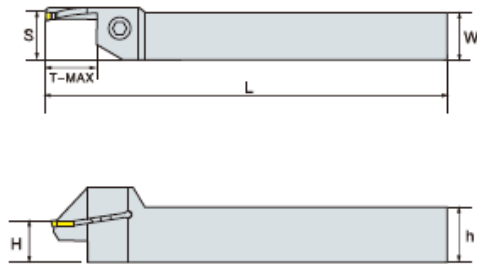
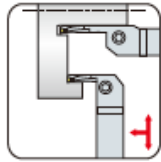

Cikkszám	Méret (mm)							Lapka	Szorító csavar	Csavarkulcs	Ár
	W	H-h	L	S	T-MAX	DMIN	DMAX				
ET-FGHH320R-25/30	20	20	125	20.6	13	25	30	FMM300R-03	M6X20N	L5	€25
ET-FGHH320R-30/35	20	20	125	20.6	13	30	35				€25
ET-FGHH320R-35/48	20	20	125	20.6	13	35	48				€25
ET-FGHH320R-48/60	20	20	125	20.6	22	48	60	FGD300R-03 FGM300R-03			€25
ET-FGHH320R-60/75	20	20	125	20.6	22	60	75				€25
ET-FGHH320R-75/100	20	20	125	20.6	22	75	100				€25
ET-FGHH320R-100/140	20	20	125	20.6	22	100	140				€25
ET-FGHH325R-25/30	25	25	150	25.6	13	25	30	FMM300R-03			€25
ET-FGHH325R-30/35	25	25	150	25.6	13	30	35				€25
ET-FGHH325R-35/48	25	25	150	25.6	13	35	48				€25
ET-FGHH325R-48/60	25	25	150	25.6	22	48	60	FGD300R-03 FGM300R-03			€25
ET-FGHH325R-60/75	25	25	150	25.6	22	60	75				€25
ET-FGHH325R-75/100	25	25	150	25.6	22	75	100		€25		
ET-FGHH325R-100/140	25	25	150	25.6	22	100	140		€25		

FGHH

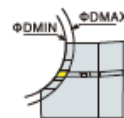
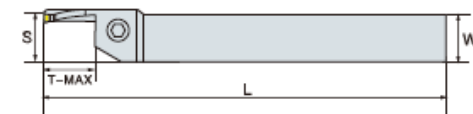
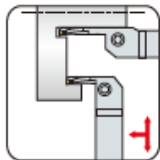

Cikkszám	Méret (mm)							Lapka	Szorító csavar	Csavarkulcs	Ár
	W	H-h	L	S	T-MAX	DMIN	DMAX				
ET-FGHH420R-25/30	20	20	125	20.6	13	25	30	FMM400R-04	M6X20N	L5	€25
ET-FGHH420R-30/35	20	20	125	20.6	13	30	35				€25
ET-FGHH420R-35/48	20	20	125	20.6	13	35	48				€25
ET-FGHH420R-48/60	20	20	125	20.6	22	48	60	FGD400R-04 FGM400R-04			€25
ET-FGHH420R-60/75	20	20	125	20.6	22	60	75				€25
ET-FGHH420R-75/100	20	20	125	20.6	22	75	100				€25
ET-FGHH420R-100/140	20	20	125	20.6	22	100	140				€25
ET-FGHH425R-25/30	25	25	150	25.6	13	25	30	FMM400R-04			€25
ET-FGHH425R-30/35	25	25	150	25.6	13	30	35				€25
ET-FGHH425R-35/48	25	25	150	25.6	13	35	48				€25
ET-FGHH425R-48/60	25	25	150	25.6	22	48	60	FGD400R-04 FGM400R-04			€25
ET-FGHH425R-60/75	25	25	150	25.6	22	60	75				€25
ET-FGHH425R-75/100	25	25	150	25.6	22	75	100		€25		
ET-FGHH425R-100/140	25	25	150	25.6	22	100	140		€25		



MGIVR/L

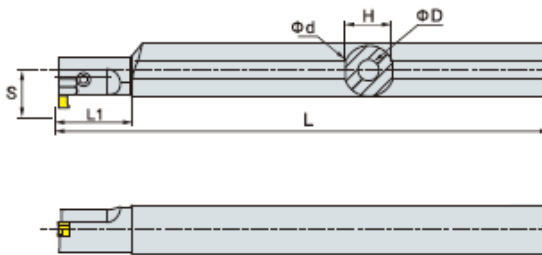
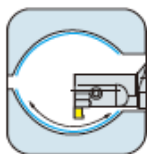

Cikkszám	Méret (mm)							Lapka	Szorító csavar	Csavarkulcs	Ár
	D	d	L	L1	T	H	S				
ET-MGIVR/L2016-1.5	20	16	125	35	4	15	11.3	MGMN150-G	M4X10N	L3.0	€25
ET-MGIVR/L2520-1.5	25	20	150	45	4	18	13.1		M4X12N	L3.0	€25
ET-MGIVR/L2925-1.5	29	25	200	45	4	23	16.2				€25
ET-MGIVR/L2016-2	20	16	125	35	5	15	12.4	MGMN200-G MGMN200-M MRMN200-M	M4X10N	L3.0	€25
ET-MGIVR/L2520-2	25	20	150	45	5	18	14.0		M4X12N	L3.0	€25
ET-MGIVR/L2925-2	29	25	200	45	5	23	17.2				€25
ET-MGIVR/L2016-2.5	20	16	125	35	6	15	12.5	MGMN250-G MGMN250-M	M4X10N	L3.0	€25
ET-MGIVR/L2520-2.5	25	20	150	45	6	18	15.1		M4X12N	L3.0	€25
ET-MGIVR/L2925-2.5	29	25	200	45	6	23	18.2				€25
ET-MGIVR/L2520-3	25	20	150	45	6	18	15.6	MGMN300-M/G/T MGMN300-M MRMN300-M MRMN300-L/R	M9X12N	L4.0	€25
ET-MGIVR/L3125-3	31	25	200	45	6	25	18.9		M5X16N		€25
ET-MGIVR/L3732-3	37	32	250	65	6	30	21.5		M5X12N		€25
ET-MGIVR/L2520-4	25	20	150	45	6	18	15.6	MGMN400-M/G/T MGMN400-M MRMN400-M MRMN400-L/R	M4X12N	L4.0	€25
ET-MGIVR/L3125-4	31	25	200	45	6	23	18.9		M5X12N		€25
ET-MGIVR/L3732-4	37	32	250	65	6	30	21.5				€25
ET-MGIVR/L3125-5	31	25	200	45	8	25	19.4	MGMN500..			€25
ET-MGIVR/L3732-5	37	32	250	65	8	30	21.5				€25

SGTR/L

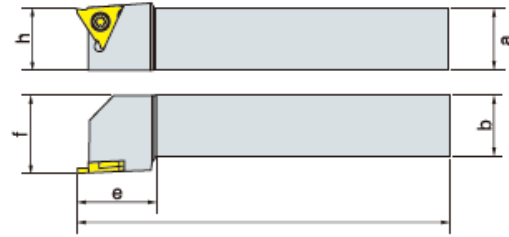

Cikkszám	Méret (mm)						Lapka	Csavar	Csavarkulcs	Ár
	a	b	L	e	h	f				
ET-SGTR/L1212H16C	12	12	100	20	12	16	JTGR/L3..	M3.5X9	T-15	€25
ET-SGTR/L1616H16C	16	16	100	20	16	20				€25
ET-SGTR/L2020K16C	20	20	125	20	20	25				€25
ET-SGTR/L2525M16C	25	25	150	20	25	32				€25
ET-SGTR/L2020K22C	20	20	125	30	20	25	JTGR/L4..	M4X10N	T-15	€25
ET-SGTR/L2525M22C	25	25	150	30	25	32				€25

STGR/L

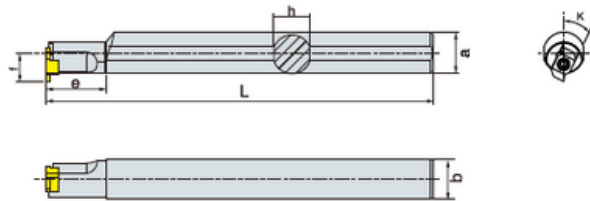

Cikkszám	Méret (mm)							Lapka	Csavar	Csavarkulcs	Ár
	a	b	f	L	e	h	K				
ET-S20Q-STGR/L16C	28	20	13	180	25	19	19	JTGR/L3..	M3.5X9	T-15	€25
ET-S25R-STGR/L16C	31	25	15.5	200	25	24	16				€25
ET-S32S-STGR/L16C	38	32	19	250	25	30	12				€35

GHV

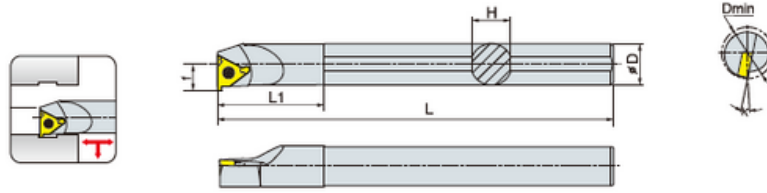

Cikkszám	Méret (mm)						Lapka	Csavar	Csavarkulcs	Ár
	Dmin	D	f	L	L1	H				
ET-GHVR1310M11-A16	13	16	6.5	150	30	15	TC1102	M2.5X8	T8	€25
ET-GHVR1613M11-A16	16	16	8	150	35	15				€25
ET-GHVR1613M16-A16	16	16	8.5	150	35	15	TC1613	M3.5X9	T15	€25
ET-GHVR2016Q16-16	20	16	11	180	35	15				€25
ET-GHVR2525Q16-16	25	20	13	180	38	18				€25
ET-GHVR3125R16-16	31	25	16	200	50	23				€35

SNGR/L

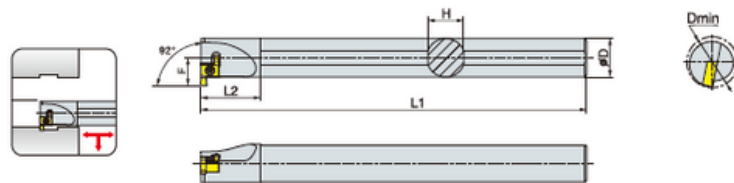

Cikkszám	Méret (mm)						Lapka	Csavar	Csavarkulcs	Ár
	Dmin	D	F	L1	L2	H				
ET-SNGR/L08H07	10	8	7	100	23	5.6	7GR 8GR	M2.2X6	T6	€25
ET-SNGR/L10H07	12	10	9	125	29	6.5				€25
ET-SNGR/L10K08	12	10	9	125	29	6.5	8GR	M2.2X6	T6	€25
ET-SNGR/L12M08	16	12	11	150	30	8.6				€25
ET-SNGR/L16Q09	20	16	15	180	30	11.6	9GR	M2.2X8	T8	€25
ET-SNGR/L20R09	24	20	19	200	30	13.6				€25

CMSNR/L-F

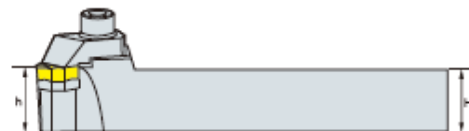
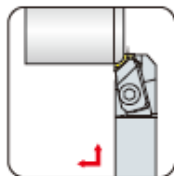

Cikkszám	Méret (mm)						Lapka	Szorító	Screw	Alátét	Screw	Csavarkulcs	Ár
	H	W	L	S	h	L1							
ET-CMSNR/L2020B-L12F	20	20	140	20	20	30	MC12 MC12.-BR	CBH4RR/L	M6X20N	SX42CB	M3X8T	L4	€25
ET-CMSNR/L2023B-L12F	20	23	140	23	20	32							€25
ET-CMSNR/L2525B-L12F	25	25	140	25	25	35	MC15..	CBH5RR/L	M6X20N	SX52CB	M3X8T	L4	€25

CMSNR/L-B

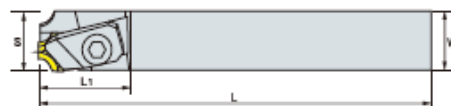
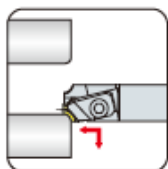

Cikkszám	Méret (mm)								Lapka	Szorító	Csavar	Csavarkulcs	Ár
	D	H	W	L	S	h	L1						
ET-CMSNR/L2020B-L12B-D20	20	20	20	140	20	20	30	MC12 MC12.-BR	CBH4RR/L	M6X20N	L4	€25	
ET-CMSNR/L2525B-L12B-D20	20	25	25	140	25	25	30					€25	
ET-CMSNR/L1620B-L12B-D20	20	16	20	140	17	16	32					€25	
ET-CMSNR/L2023B-L12B-D20	28	20	23	140	23	20	32					€25	

SRGPR/L-E

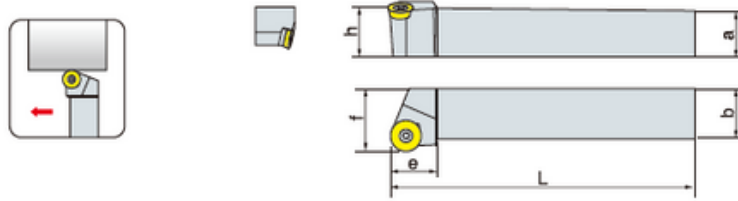

Cikkszám	Méret (mm)						Lapka	Csavar	Csavarkulcs	Ár
	a	b	L	h	f	e				
ET-SRGPR/L2020B-L12E	20	20	140	20	20	20	RPCT1203MO	M3.5X9	T15	€25
ET-SRGPR/L2020B-L16E	20	20	140	20	25	20	RPCT1604MO	M3.5X9	T15	€25
ET-SRGPR/L2525B-L20E	25	25	140	25	32	30	RPCT2004MO	M5X12	T20	€25

SRGPR/L-F

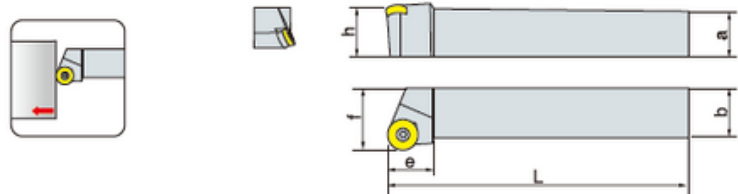

Cikkszám	Méret (mm)						Lapka	Csavar	Csavarkulcs	Ár
	a	b	L	h	f	e				
ET-SRGPR/L2020B-L12F	20	20	140	20	20	20	RPCT1203MO	M3.5X9	T15	€25
ET-SRGPR/L2020B-L16F	20	20	140	20	25	20	RPCT1604MO	M3.5X9	T15	€25
ET-SRGPR/L2525B-L20F	25	25	140	25	32	30	RPCT2004MO	M5X12	T20	€25

SRCPR/L-B

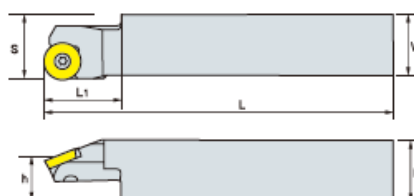
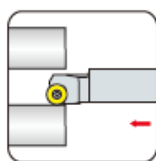

Cikkszám	Méret (mm)							Lapka	Csavar	Csavarkulcs	Ár
	D	H	W	L	S	h	L1				
ET-SRCPR/L2020B-L08B-D12	12	20	20	140	21.5	15.5	25	RPCT0802MO	M3X8	T8	€25
ET-SRCPR/L1919B-L12B-D15	15	19	19	140	16	16	25	RPCT1203MO	M3.5X9	T15	€25
ET-SRCPR/L2020B-L12B-D20	20	20	20	140	15.5	15.5	25				€25
ET-SRCPR/L2525B-L16B-D32	32	25	25	140	20	20	30	RPCT1604MO	M5X12	T20	€25

CSKPR/L

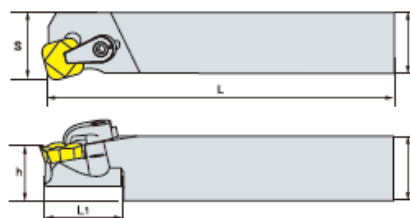
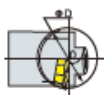
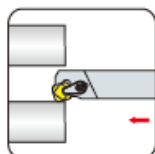

Cikkszám	Méret (mm)							Lapka	Szorító	Csavar	Csavarkulcs	Ár
	D	H	W	L	S	h	L1					
ET-CSKPR/L2020B-L12B-D25	25	20	20	140	22	15.5	25	SPGR120440L	CS6R1	MIO622	L3	€25

SSKPR/L

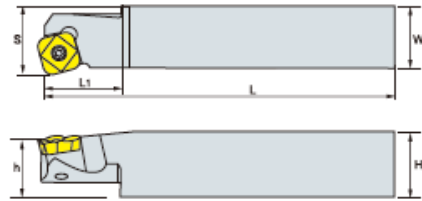
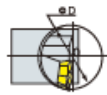
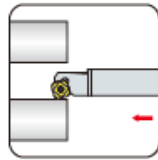

Cikkszám	Méret (mm)							Lapka	Csavar	Csavarkulcs	Ár
	D	H	W	L	S	h	L1				
ET-SSKPR/L2020B-L09B-D12	11.5	20	20	140	22	15.5	25	SPGT090330L	M3X8	T8	€25
ET-SSKPR/L2020B-L09B-D13	13	20	20	140	22	15.5	25				€25
ET-SSKPR/L2020B-L09B-D20	20	20	20	140	22	15.5	25				€25

CKFNR

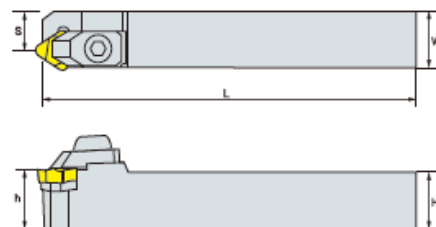
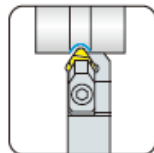

Cikkszám	Méret (mm)					Lapka	Ár
	H	W	L	S	h		
ET-CKFNR2020B-L22RW	20	20	140	13	20	TNG2204R	€25
ET-CKFNR2020B-L27RW	20	20	140	12	20	TNG2704R	€25
ET-CKFNR2020B-L33RW	20	20	140	10	20	TNG3306R	€25
ET-CKFNR2525B-L44RW	25	25	140	12	25	TNG4408R	€25

CKFNR

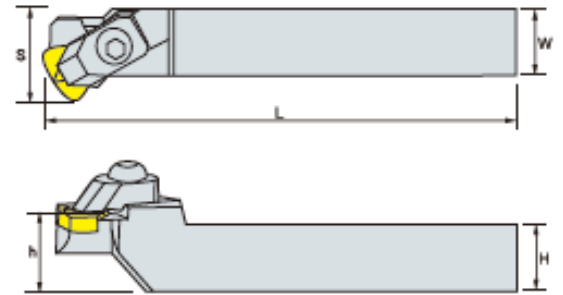
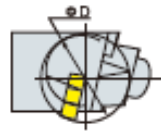
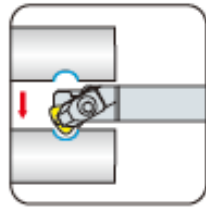

Cikkszám	Méret (mm)						Lapka	Ár
	D	H	W	L	S	h		
ET-CKFNR2022B-L22RW-D23	23	20	22	140	25	20	TNG2204L	€25
ET-CKFNR2022B-L27RW-D25	25	20	22	140	25	20	TNG2704L	€25
ET-CKFNR2025B-L33RW-D38	38	20	25	140	32	20	TNG3306L	€35
ET-CKFNR2528B-L38RW-D50	50	25	25	140	40	25	TNG3806L	€35
ET-CKFNR2528B-L44RW-D52	52	25	28	140	40	25	TNG4408L	€35

CSG NR/L

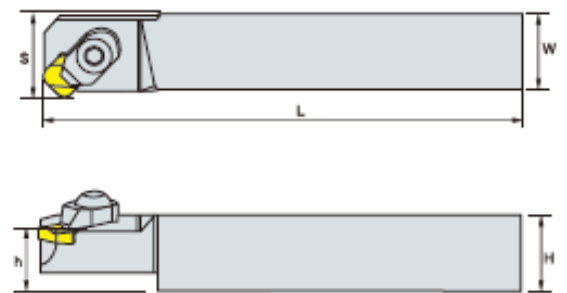
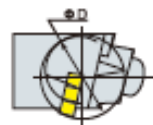
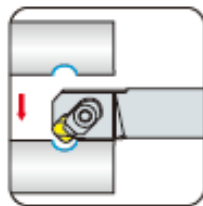

Cikkszám	Méret (mm)						Lapka	Ár
	D	H	W	L	S	h		
ET-CSG NR/L2020B-L09RW-D15	15	20	20	140	22	20	SNGN0903WL	€35
ET-CSG NR/L2020B-L09RW-D22	22	20	20	140	22	15.5	SNGN0903WR	€35

CSBNR/L

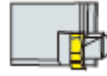
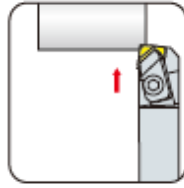

Cikkszám	Méret (mm)					Lapka	Ár
	H	W	L	S	h		
ET-CSBNR/2020B-L12BS	20	20	140	19	20	SNGN1204R/L	€25
ET-CSBNR/2020B-L15BS	25	25	140	24	25	SNGN1504R/L	€25

CSKNR/L

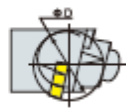
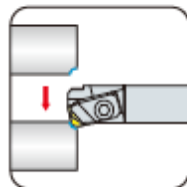

Cikkszám	Méret (mm)						Lapka	Ár
	D	H	W	L	S	h		
ET-CSKNR/L1622B-L09BS-D14	14	16	22	140	27	16	SNGN0903SL/R	€25
ET-CSKNR/L2022B-L12BS-D26	26	20	22	140	27	20	SNGN1204SL/R	€25
ET-CSKNR/L2525B-L15BS-D35	35	25	25	140	32	25	SNGN1504SL/R	€35

CTGNR/L

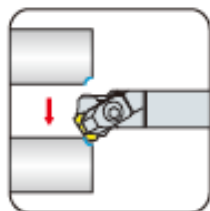

Cikkszám	Méret (mm)						Lapka	Ár
	D	H	W	L	s	h		
ET-CTGNR/L2021B-K22BS-D23	23	20	21	140	28	20	TNGN2204SL/R	€25